

Timesaver cast iron drainage systems

UNICLASS L7315	
CI/Sfb	(52.5)
AUGUST 2015	

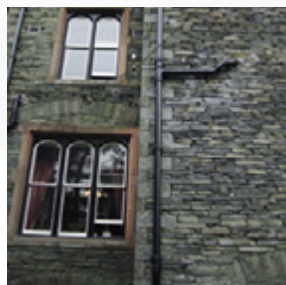

TIMESAVER • **HERITAGE** • **VORTX**

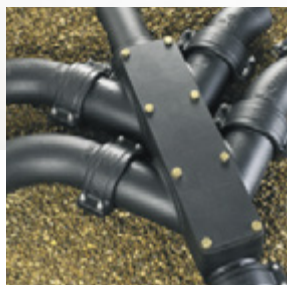



Head Office

Lows Lane, Stanton-by-Dale, Ilkeston,
Derbyshire DE7 4QU

Tel: 0115 930 5000 Fax: 0115 932 9513

Email: sales.uk.pam@saint-gobain.com

www.saint-gobain-pam.co.uk (Click on Soil and Drain)

Note: Our policy of continuing product development and improvement necessitates that we reserve the right to modify designs shown in this brochure without prior notice.

Contents

Introduction

The company	2
Quality assurance	3
Benefits of cast iron	4
Why specify Timesaver	5

Section 1

Drain Pipes and Fittings	7
Joining method	8
Pipes and fittings range	9
Traditional drain fittings	29
BIM Library	31
Design recommendations	32
Connection to other systems	35
Quality control procedures and tests	36

Section 2

Soil Pipes and Fittings	37
Joining method	38
Electrical continuity	39
Pipes and fittings range	40
Support for vertical pipework	54
Support for low gradients	55
Connection to other materials	56

Heritage Couplings

<i>Joining method</i>	58
<i>Design recommendations</i>	59
<i>Product range compatibility</i>	60

Technical details	61
Chemical resistance	62
Standard specifications	64

Section 3

VortX floor & shower drains and roof outlets	65
Floor drains	66
Shower drains	73
Roof outlets	75

Introduction



Saint-Gobain PAM UK is the primary supplier of ductile iron pipes and fittings, manhole covers, gullies and grates, as well as being the leading producer of cast iron above and below ground drainage systems. Its markets include water and sewerage, telecommunications, highways, civil engineering, construction and housing.

Saint-Gobain PAM UK specialises in the manufacture of cast iron above and below ground drainage systems and rainwater and gutter systems.

Saint-Gobain PAM UK maintains a programme of quality controls, licenced under BS EN ISO 9001 Quality Assurance as recognition of its high standard of production competence.

The Timesaver system was first launched in 1973, for use on above ground soil and ventilating installations.

In 1980 a below ground Timesaver system was launched to complement the soil range, and together they became market leaders in cast iron drainage. Both systems were recognised for their quality performance, and were awarded the highly coveted BSI Kitemark in 1982.

Product ranges

Other products manufactured by Saint-Gobain PAM UK:

Ensign BS EN 877 : Cast iron above and below ground drainage system. Kitemark approved to the product standard BS EN 877, fully meeting ISO 6594, and holds full BBA Agrément Certification 95/3125 (4th edition).

Ensign EEZI-FIT BS EN 877 : A new push-fit range of cast iron fittings and couplings in 100mm and 150mm diameter for gravity sanitary installations.

EPAMS: A complete siphonic rainwater system, consisting of steel siphonic roof outlets and cast iron pipework BBA certificate 06/4328

Classical: Traditional ranges of cast iron rainwater downpipes and fittings and gutter systems produced in accordance with BS 460.

Classical 'Plus': Cast Iron rainwater gutter systems available in a factory applied finished coat for immediate installation. Black supplied as standard, other colours available to order.

Classical Express: Double spigot half round gutter system in 125mm size with higher capacity jointed by mechanical clips, available in primer or plus finish. Quick and easy to install – cost effective against cast aluminium.

Technical advisory service: In support of Saint-Gobain PAM UK extensive manufacturing resources, an advisory service department is available to customers to provide technical assistance and guidance on soil, rainwater and below ground drain installations, including free take off service. Full siphonic rainwater design, and technical support can also be provided.

Telephone Technical Helpline: 01952 262529.

Website: www.saint-gobain-pam.co.uk

The website contains all the product literature for the brands Ensign, Timesaver and Classical including Ensign CAD drawings.

Other information includes:

Soil and Drain training centre which includes interactive training modules for Soil and Rainwater systems.

Technical centre and all the latest press information.

Copyright

© Saint-Gobain PAM. No part of this manual may be reproduced, stored in a retrieval system, or transmitted in any form, or by any means electronic, mechanical recording, or otherwise, without the written consent of the copyright owner.

Liability

The Timesaver manual is written for general guidance only. Therefore no responsibility can be accepted for any errors, omissions or incorrect assumptions.

Saint-Gobain PAM do not accept liability for any complaints on installations where components not manufactured by Saint-Gobain PAM are responsible. Whilst every care has been taken to ensure that the information contained in this catalogue is correct, Saint-Gobain PAM or its agents do not accept responsibility for any errors herein.

Our policy is one of continuous improvement. We therefore also reserve the right to change or alter the specification of any product without notice.

Quality assurance



Timesaver carries the coveted British Standard Kitemark for above and below ground systems.

BS 416 Part 2

For soil, waste and ventilating pipes and fittings

BS 437

For drain pipes and fittings

BS 6087

For flexible joints for BS 416 Part 2 and BS 437 pipes and fittings

If customers have any doubts or queries about the suitability of any Saint-Gobain PAM product, they should contact the Saint-Gobain PAM UK Customer Service Unit on: 0115 989 8066

Technical helpline:
01952 262529



BS EN ISO 9001:2008 – Registered No: FM12908

Products included in this manual are manufactured under the BS EN ISO 9001 Quality Assurance Scheme.

Timesaver systems carry the BS Kitemark, providing the highest guarantee of product quality, reliability and safety.

A strict quality control system is maintained throughout the company from purchasing of raw materials to the inspection and testing of products. Spontaneous checks made throughout the year by the BSI Inspectorate, ensure that the set standards are not allowed to fall.

Kitemark licences can only be secured when quality control systems, as laid down in BS EN ISO 9001, have been implemented and approved by the BSI.

BS EN ISO 9001 legislates for Quality Assurance and may be chosen as an alternative 'third party guarantee'. It also provides a means of underwriting the quality of products which lie outside the scope of product standards such as BS 416 and BS 437.

On occasions, owing to pressure on normal production units, it may be necessary to manufacture certain components outside the confines of the BS EN ISO 9001 Quality Assurance Licence. Such items will be produced, however, to a quality in keeping with that of accredited manufacturing units.

Components so produced will be identified on the order acknowledgement.

Commitment to quality

Saint-Gobain PAM UK is committed to satisfying its customers' needs in both quality products and services.

It recognises the necessity for continual improvement in all disciplines throughout the organisation, and clearly states this objective to its employees at all levels.

As a basis for this objective, the company is committed to operating strict quality management systems in accordance with BS EN ISO 9001. It also recognises the responsibility of the company's employees in meeting the quality objectives and is conscious of their training and development needs.

Environment Standard BS EN ISO 14001: 2004

Saint-Gobain PAM UK manufacturing sites, including Sinclair at Telford, have been awarded the 'Manufacturing to Environmental Standards' accreditation BS EN ISO 14001: 2004 which was developed to help manufacturers maintain and improve their management of environmental responsibilities and assist them in ensuring compliance with environmental laws and regulations.

Saint-Gobain PAM UK operates Integrated Pollution and Preventative Control (IPPC) regulations, and have implemented comprehensive environmental management systems throughout its manufacturing sites.

CEMARS certification

(Certified Emissions Measurement And Reduction Scheme)

Saint-Gobain PAM UK has been awarded certification to the world class, ISO-accredited CEMARS (Certified Emissions Measurement And Reduction Scheme) standard by the Achilles carbonReduction programme.

CEMARS certification demonstrates the company's commitment to measuring, managing and reducing greenhouse gas emissions in a robust and credible way.

It confirms the company has measured its greenhouse gas emissions in compliance with ISO 14064-1:2006 and has committed to managing and reducing its emissions in respect of all operational activities across its Water & Sewer, Municipals and Soil & Drain business units.

Saint-Gobain PAM UK has achieved CEMARS for its operational carbon footprint for the period 2011–2014.

Benefits of cast iron



Superior strength

Exceptional crush resistance - vastly superior to other materials

- Timesaver BS437 150KN/m
- Clay 40KN/m
- PVC 6KN/m
- The strongest soil and drain system – no contest
- Exceptional crush resistance – vastly superior to HDPE and PVC
- Exceptional resistance to over vigorous rodding
- No. 1 choice for exposed areas i.e. car parks, shopping centres, inner cities – which are accessible to damage by accidental impact or vandalism
- Used in areas where ground is unstable or the trenches are shallow
- Less bedding required.

Non-combustible

- Cast iron provides up to 4 hours fire integrity
- Cast iron has no calorific values (i.e. substances which actually fuel the fire) and therefore will not assist the spread of fire
- Cast iron will not emit toxic fumes unlike PVC-u and sooty smog like HDPE, which is often the cause of death during the first 30 minutes of a fire
- The cast iron system will not collapse under the intense heat, unlike PVC-u and HDPE which can be life threatening to occupants and rescue teams
- No fire protection required when penetrating floors in accordance with document B.

Noise reduction (the silent solution)

- Cast iron is the quietest system with exceptional sound deadening qualities (proven)
- Tests carried out in a laboratory in Germany to BS EN 14366 show cast iron up to 10dB(A) quieter than most other materials.

Sustainable (the environmental choice)

- 100% recyclable – produced from virtually 100% recyclable scrap
- Greenpeace recommended – no greater approbation
- Cast iron should never be a candidate for landfill
- Production creates no toxic waste
- Best drainage solution on land reclamation sites
- Less bedding, less supports, less insulation – less is more when it comes to safeguarding natural resources
- Life time promise – not uncommon to exceed 100 years – minimal environmental impact.

Ease of installation

- Simple mechanical couplings or push-fit couplings
- No special tools like butt fusion machines needed to install HDPE at substantial cost or rental
- Installation cast iron has no added complications: fire collars/cladding, additional brackets, sound insulation, expansion joints, thermal limiters etc. unlike PVC-u and HDPE.

Cost effective

- No. 1 choice for PFI projects
- Fit and forget – minimal maintenance for lease period
- Lifetime expectancy
- Can often be the most cost effective option when total installed cost is measured, expected maintenance required and a full risk assessment carried out – i.e. the consequential cost of failure in the system.

No expansion joints

- The coefficients of linear expansion for cast iron and concrete are almost identical
- This makes cast iron a highly suitable material where drainage systems are required to pierce concrete floor slabs
- No special jointing to allow for differential expansion is needed. In contrast, PVC-u piping requires an expansion joint every 3m, as well as expensive thermal limiters.

Benefits of cast iron



Longevity

● There are two elements of an above ground drainage system that should be designed and specified to last the lifetime of the building:

1. the internal rainwater pipes
2. the soil discharge stacks

Even when a building is modernised every 15 or 20 years, these elements along with the structure will likely remain. If the toilet or kitchen area is refurbished, the branch discharge pipes will often be renewed and therefore it may be appropriate to specify other materials for that element. But if the main stacks are to be specified to last the lifetime of a building, perhaps 50-70 years or more, the appropriate material is mechanical jointed cast iron, for it is one of few materials you can reasonably fit and forget, as recognised by specifiers on many of the new PFI-type projects.

Why specify Timesaver



Proven drainage system for nearly 40 years

The Timesaver system, was first launched in 1973, for use on above ground soil and ventilating installations.

In 1980 a below ground Timesaver system was launched to complement the soil range, and together they became market leaders in cast iron drainage.

Both systems were recognised for their quality performance, and were awarded the highly coveted BS Kitemark in 1982.

Refurbishment

Prestigious commercial buildings built in the 1970's to the mid 90's which are serviced by cast iron soil stacks, will most likely be Timesaver. If the building is to be refurbished and changes are required, the latest Timesaver range is best suited to connect to the original pipework.



Why specify Timesaver



Timesaver Heritage couplings give traditional appearance

The Timesaver range contains push-fit couplings that turns a mechanical pipe system into a system with a traditional socket appearance of yesteryear, as depicted in BS 416 Part 1.

Its primer black coating makes it easy to overpaint for external soil stacks, and is the perfect solution for listed buildings and those situated in areas of conservation. Pipes are available in 3m lengths or in the traditional 1.8m (6ft) length, in 75 and 100mm diameter and by using the Timesaver Heritage couplings, waste is minimised and installation time, compared to the old socket/spigot caulking method, is significantly reduced.

The Timesaver Heritage couplings have been accepted by recognised bodies for all grade listed properties i.e. National Heritage, English Heritage etc.

Strength

Timesaver is recognised as the strongest of all the drainage systems in any material, in particular for below ground applications. The substantial section thickness of BS 437, makes it the first choice for under building drainage, especially on commercial buildings where fit and forget is a high priority and provides peace of mind.

Also in areas where the drainage is to be installed in unstable ground, or ground containing methane gases, the strength of Timesaver puts it out on its own.

The above ground soil range with its increased section thickness, can provide further strengths in areas where impact can occur i.e. externally on the building fabric and car parks.

British Standard designs

The Timesaver ranges are based on British Standards BS 416 Part 2 for above ground and BS 437 for below ground and as such, contain fittings and diameters appropriate to those standards. In particular the below ground range contains an extensive range of traps/raising pieces and inspection chambers in 100, 150 and 225mm diameters.



Extensive access fittings

One of the main traits of British design was not only its attention to maintaining the drainage flow with swept branches, but also making sure sufficient access to the system was provided to ensure any blockages could be easily cleared. As a result, the Timesaver range carries more access fittings than any cast iron system on the market, for above and below ground.



Connections to waste systems

Timesaver offers a number of fittings to be able to connect to waste pipes to the mainstack i.e. boss pipes, push-fit or threaded (BSPT) but also includes the 'strap-on-boss' fitting which enables connection cutting into the pipe.



Section 1

Drain Pipes and Fittings



Joining method



- A. Pipe or fitting
- B. Pipe or fitting
- C. Synthetic rubber gasket
- D. Coupling
- E. Stainless steel set screws and nuts

All couplings have four set screws and nuts.

Couplings are supplied ready assembled

1. Slacken bolts to fullest extent.
2. Place synthetic rubber gasket on end of pipe or fitting A, and slide loosely assembled coupling over pipe B.
3. Fit pipe B into gasket ensuring both A and B are butting against the internal central register.
4. Slide coupling over gasket ensuring that it is centrally located and tighten bolts alternately so that the gap between coupler halves is even on both sides. When hand tight check alignment of assembly.
5. Complete tightening operation by use of a Ratchet Spanner – EF100 and Deep Socket – EF101 until a suitable resistance is achieved (min 20Nm).

Joints may be deflected up to 5° without affecting the sealing properties.

The Timesaver couplings meet the performance requirements of BS 6087:1990 and incorporate synthetic rubber gaskets conforming to BS EN 681-1/ISO 4633 and stainless steel set screws and nuts conforming to BS 970 Part 2. A Ratchet Spanner – EF100 is the recommended tool required to tighten the stainless steel set screws which give a 'for all time seal' water and airtight installation.

Saint-Gobain PAM UK do not accept liability for any complaints on installations where components not manufactured by Saint-Gobain PAM UK are included.

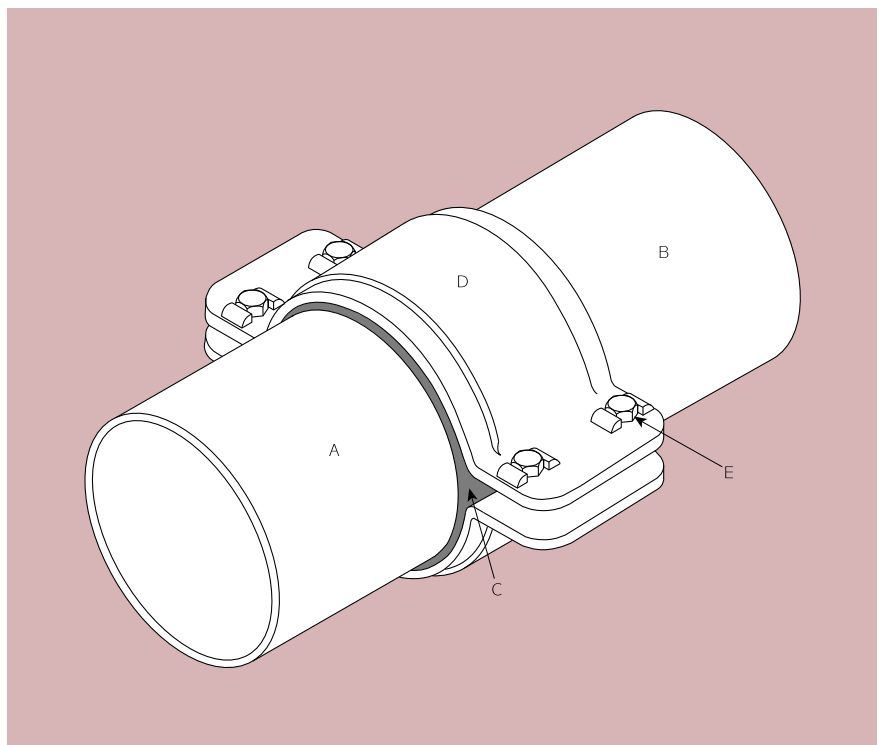

Pipes double spigot

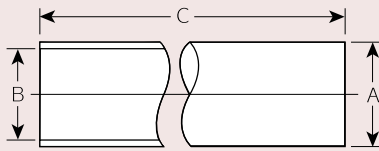

Product code	Dia	A Max o/dia	B Min i/dia	Min section	C Metre lengths available	Nominal wt per metre kg
Pipe – TD00						
156568	100	119	99	7	3	18.7
156832	150	173	150	8	3	31.7
157042	225	256	225	10	3	60.0

Pipes are internally lined with a two part epoxy paint (ochre colour). Externally coated with black acrylic paint and stencilled every metre with blue marking.

Brackets fixing

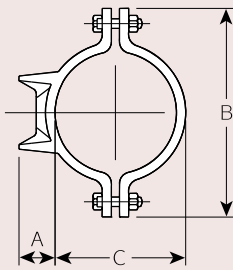

Product code	Dia	A	B	C	Nominal wt/kg
Wall fixing or hanging brackets – TD640					
191358	100	40	205	130	2.3
191359	150	40	255	175	2.8
192374	225	18	358	260	4.0

Fixing hole in bracket is plain without BSPT thread (see page 34). 225 bracket is manufactured from mild steel-coated in a red anti-rust primer.

Couplings standard and transitional

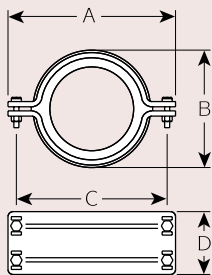

Standard

Ductile iron coupling with stainless steel nuts and set screws and synthetic rubber gasket for jointing Timesaver drain to Timesaver drain (black gasket with identity marking).

Product code	Dia	A	B	C	D	*E	Nominal wt/kg
Two-piece ductile iron coupling – TD01							
191294	100	203	140	180	75	5	2.8
191295	150	252	195	230	75	5	3.6
191296	225	345	290	320	100	5	7.8

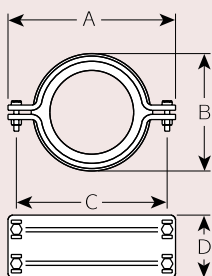

Transitional

Ductile iron coupling with stainless steel nuts and set screws and synthetic rubber gasket for jointing Timesaver drain to Timesaver soil or Ensign soil (black gasket with identity marking). Electrical continuity clips are available supplied separately in standard quantity bags of 25 number (see ref table page 39).

Product code	Dia	A	B	C	D	*E	Nominal wt/kg
Two-piece ductile iron coupling – TD02							
191297	100	203	140	180	75	5	2.8
191298	150	252	195	230	75	5	3.6

Four set screws are supplied on all couplings TD01/TD02. Electrical continuity clips are available supplied separately in standard quantity bags of 25 number (see ref table page 39). *Minimum allowance (E) to accommodate gasket register (for guidance only).

Tools

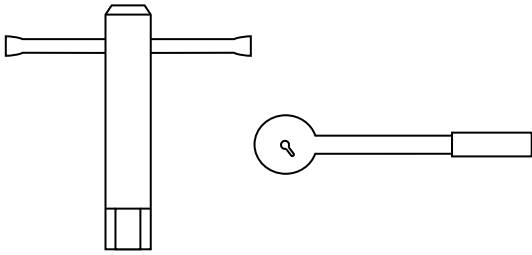

Ratchet spanner – EF100: product code 191201

A ratchet spanner is the recommended tool required to tighten the stainless steel screws, used in conjunction with a deep socket – EF101: product code 191202.

'T' box spanner – EF098: product code 191200

13mm A/F, dual purpose, for use with Timesaver and Ensign systems.

Bends medium radius

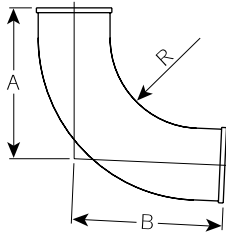

Product code	Dia	A	B	R	Nominal wt/kg
87½° Bend • Medium radius – TD06					
191219	100	250	250	150	8.8
191225	150	275	275	150	16.0
191229	225	335	335	150	41.5

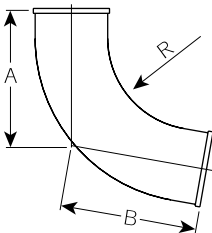

Product code	Dia	A	B	R	Nominal wt/kg
80° Bend • Medium radius – TD06					
191218	100	225	225	150	8.1

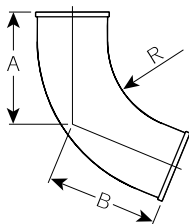

Product code	Dia	A	B	R	Nominal wt/kg
6½° Bend • Medium radius – TD06					
191217	100	190	190	150	7.0
191224	150	205	205	150	10.9

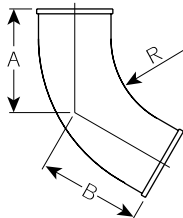

Product code	Dia	A	B	R	Nominal wt/kg
60° Bend • Medium radius – TD06					
191216	100	170	170	150	6.0

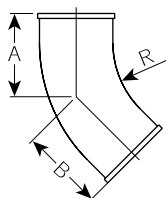

Product code	Dia	A	B	R	Nominal wt/kg
45° Bend • Medium radius – TD06					
191215	100	135	135	150	5.8
191223	150	145	145	150	11.0
191228	225	215	215	150	31.8

Bends medium radius

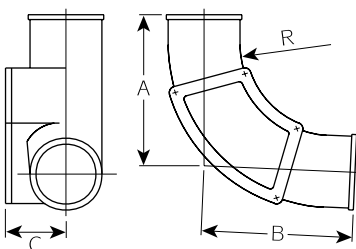
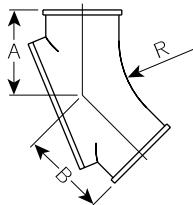
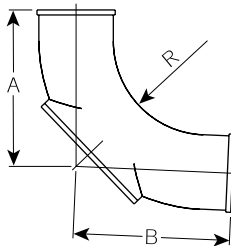
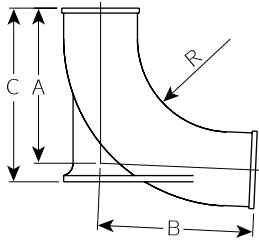
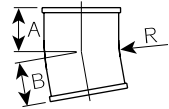
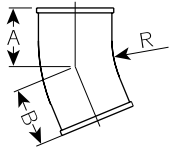
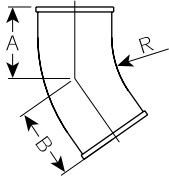

Product code	Dia	A	B	R	Nominal wt/kg
35° Bend • Medium radius – TD06					
191214	100	115	115	150	4.3
191222	150	125	125	150	9.1

Product code	Dia	A	B	R	Nominal wt/kg
22½° Bend • Medium radius – TD06					
191213	100	95	95	150	3.6
191221	150	95	95	150	7.1
191227	225	120	120	150	18.4

Product code	Dia	A	B	R	Nominal wt/kg
10° Bend • Medium radius – TD06					
191212	100	70	70	150	3.1
191220	150	70	70	150	4.5
191226	225	85	85	150	13.0

Product code	Dia	A	B	C	R	Nominal wt/kg
87½° Bend with heel rest • Medium radius – TD07						
191230	100	250	250	255	150	9.4
191231	150	275	275	310	150	19.4

Product code	Dia	A	B	R	Nominal wt/kg
87½° Bend with access rear • Medium radius – TD08					
191233	100	250	250	150	12.0
191235	150	275	275	150	21.3
191237	225	335	335	150	57.8

Product code	Dia	A	B	R	Nominal wt/kg
45° Bend with access rear • Medium radius – TD08					
191232	100	135	135	150	8.6
19234	150	145	145	150	25.9
† 191236	225	215	215	150	46.8

Product code	Dia	A	B	C	R	Nominal wt/kg
87½° Bend with access side • Medium radius – TD09						
191239	100	250	250	100	150	13.1
191241	150	275	275	120	150	20.5
† 191243	225	335	335	190	150	57.5

†Made to order.

Bends medium radius

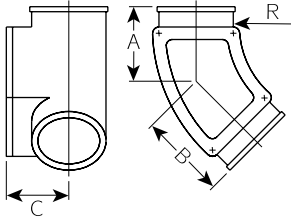

Product code	Dia	A	B	C	R	Nominal wt/kg
45° Bend with access side • Medium radius – TD09						
191238	100	135	135	100	150	10.0
191240	150	145	145	120	150	26.6
† 191242	225	215	215	190	150	46.8

Bends long radius

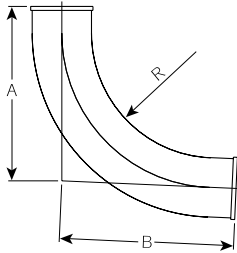

Product code	Dia	A	B	R	Nominal wt/kg
87½° Bend • Long radius – TD15					
191244	100	350	350	250	13.2
191245	150	375	375	250	25.0

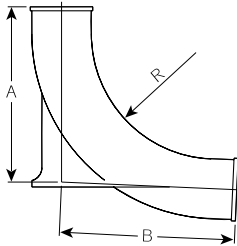

Product code	Dia	A	B	R	Nominal wt/kg
87½° Bend with heel rest • Long radius – TD22					
191246	100	350	350	250	15.0
191247	150	375	375	250	28.0

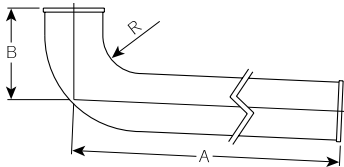

Product code	Dia	A	B	R	Nominal wt/kg
87½° Bend • Long tail – TD102					
191289	100	815	180	90	18.6

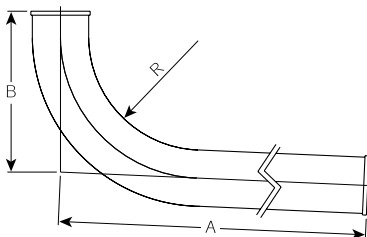

Product code	Dia	A	B	R	Nominal wt/kg
87½° Bend • Long tail – TD104					
191713	100	850	650	230	33.0
192699	150	850	650	203	54.0

Bends clearing arm

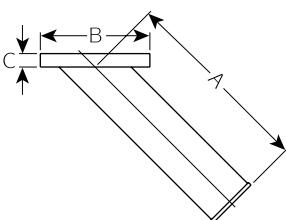

Product code	Dia	A	B	C	Nominal wt/kg
45° Bend • Clearing arm – TD425					
191292	100 x 45°	405	235	35	12.5

Can be used with gratings and covers – TD612/TD616 and raising pieces – TD525.

†Made to order.

Branches

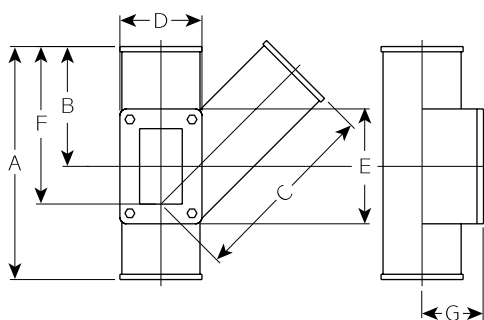
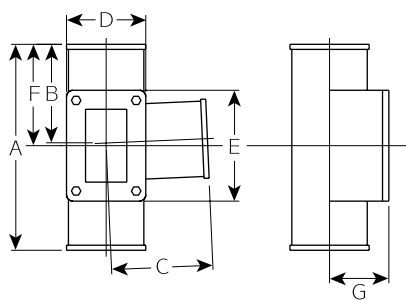
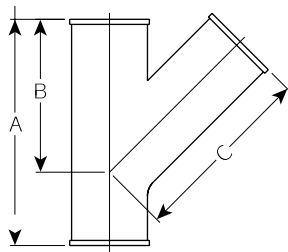
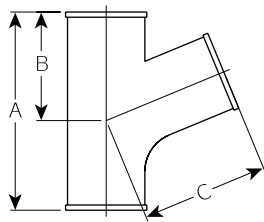
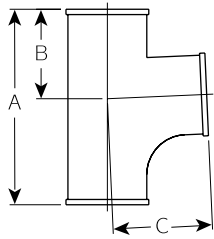

Product code	Dia	A	B	C	Nominal wt/kg
87½° Branch • Radius curve – TD37					
191250	100 x 100	295	130	150	7.8
191252	150 x 100	370	135	235	16.1
191254	150 x 150	445	170	255	19.1
191256	225 x 100	390	155	275	40.0
191258	225 x 150	460	185	295	46.3
191260	225 x 225	590	225	365	58.5

Product code	Dia	A	B	C	Nominal wt/kg
67½° Branch • Radius curve – TD37					
191249	100 x 100	305	165	195	8.8

Product code	Dia	A	B	C	Nominal wt/kg
45° Branch – TD37					
191248	100 x 100	355	245	290	11.3
191251	150 x 100	365	280	325	15.4
191253	150 x 150	435	315	355	24.4
191255	225 x 100	390	340	395	42.0
191257	225 x 150	460	375	410	45.8
191259	225 x 225	590	445	510	64.4

Product code	Dia	A	B	C	D	E	F	G	Nominal wt/kg
87½° Branch with access side RH • Radius curve – TD51									
191262	100 x 100	325	160	160	205	215	160	105	14.2
191264	150 x 100	370	140	235	175	175	140	135	20.9
† 191267	225 x 150	590	225	295	260	260	250	190	67.3
† 191269	225 x 225	590	225	365	260	260	250	190	79.5

Product code	Dia	A	B	C	D	E	F	G	Nominal wt/kg
45° Branch with access side RH – TD51									
191261	100 x 100	355	245	290	125	175	245	105	14.2
191263	150 x 100	420	300	325	175	175	200	135	21.9
† 191265	225 x 100	590	445	330	260	260	350	190	62.8
† 191266	225 x 150	590	445	355	260	260	350	190	66.8
† 191268	225 x 225	590	445	510	260	260	350	190	85.4

†Made to order.

Branches

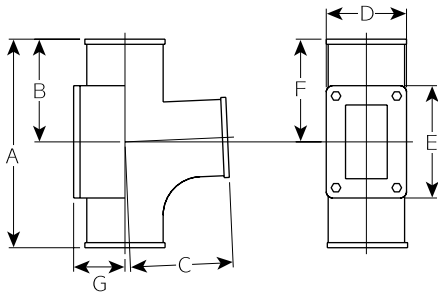

Product code	Dia	A	B	C	D	E	F	G	Nominal wt/kg
87½° Branch with access rear • Radius curve – TD52									
191271	100 x 100	325	160	160	205	215	160	80	13.4
191273	150 x 100	370	140	235	175	175	140	110	22.9
† 191275	225 x 100	590	225	275	260	260	250	190	60.0
† 191276	225 x 150	590	225	295	260	260	250	190	62.4
† 191278	225 x 225	590	225	365	260	260	250	190	79.5

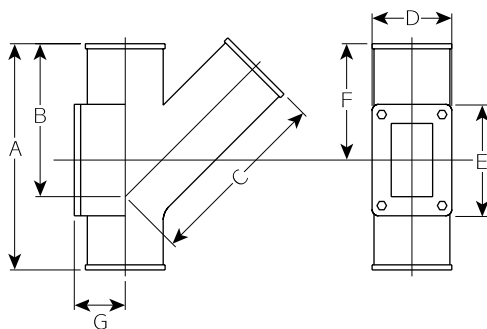

Product code	Dia	A	B	C	D	E	F	G	Nominal wt/kg
45° Branch with access rear – TD52									
191270	100 x 100	355	240	290	205	215	185	80	16.1
191272	150 x 100	420	300	325	175	175	200	110	22.9
† 191274	225 x 100	590	445	330	260	260	350	190	63.0
† 191277	225 x 225	590	445	510	260	260	350	190	84.4

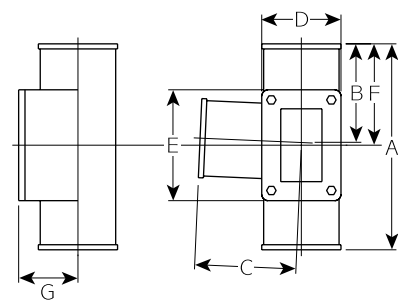

Product code	Dia	A	B	C	D	E	F	G	Nominal wt/kg
87½° Branch with access side LH • Radius curve – TD53									
191280	100 x 100	325	160	160	205	215	160	105	14.2
191282	150 x 100	370	140	235	175	175	140	135	21.2
† 191284	225 x 100	590	225	275	260	260	250	190	61.0
† 191286	225 x 150	590	225	295	260	260	250	190	67.3
† 191288	225 x 225	590	225	365	260	260	250	190	79.5

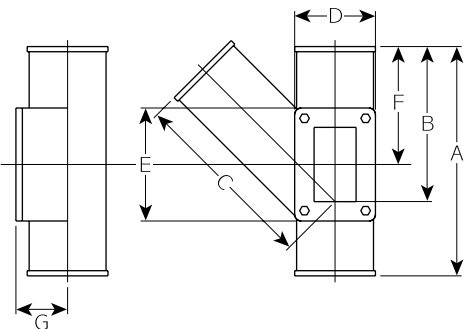

Product code	Dia	A	B	C	D	E	F	G	Nominal wt/kg
45° Branch with access side LH – TD53									
191279	100 x 100	355	245	290	125	175	245	105	14.2
191281	150 x 100	365	280	325	175	175	200	135	21.9
† 191283	225 x 100	590	445	330	260	260	350	190	62.8
† 191285	225 x 150	590	445	355	260	260	350	190	66.8
† 191287	225 x 225	590	445	510	260	260	350	190	85.4

Branches double

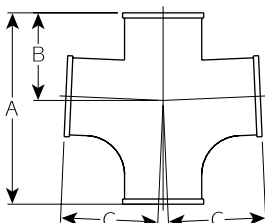

Product code	Dia	A	B	C	Nominal wt/kg
87½° Double branch • Plain – TD447					
191293	100 x 100	325	160	160	11.6

†Made to order.

Pipes access

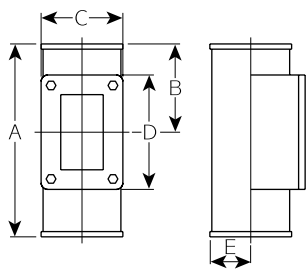

Product code	Dia	A	B	C	D	E	Nominal wt/kg
Rect door – TD56							
191344	100	270	135	125	175	95	9.7
191345	150	270	135	175	175	125	15.4
191346	225	590	250	260	260	190	62.6

Pipes taper

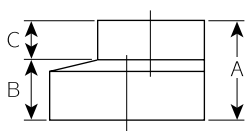

Product code	Dia	A	B	C	Nominal wt/kg
Pipes • Diminishing – TD41					
191333	150 x 100	100	47	43	3.5
191334	225 x 100	210	160	50	13.6
191335	225 x 150	210	160	50	13.4
191336	*225 x 200	100	60	40	6.2
192431	†225 x 250	152	82	70	9.8

NEW

*Connects 225 Timesaver drain to 200 Ensign soil/drain.

†Connects 225 Timesaver drain to 250 Ensign soil/drain.

Socket ferrules

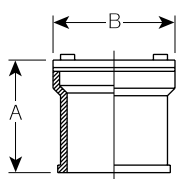

Product code	Dia	A	B	Nominal wt/kg
Socket ferrule with cast iron cap – TD36				
191330	100	120	130	3.8

Blank ends

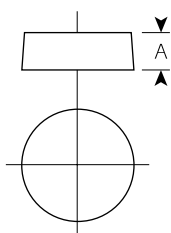

Product code	Dia	A	Nominal wt/kg
Blank ends – TD34			
191326	100	40	1.3
191327	150	40	2.6
191328	225	75	10.7

If you require blank ends drilled to accommodate 50mm waste – use GT71 (see page 49) with TD02 stepped coupling.

Pipes transitional

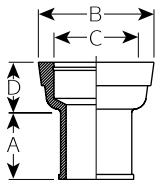
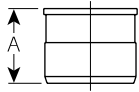

Product code	Dia	A	Nominal wt/kg
Adaptor from Timesaver drain to supersleve – TD118			
191350	100	100	2.2
191351	150	125	5.1

Product code	Dia	A	B	C	D	Nominal wt/kg
Socket for cast iron to suit BS 437 – TD47						
191341	100	100	185	135	75	8.0
191342	150	80	240	190	90	11.8
† 191343	225	120	355	275	115	31.3

Note: Transitional pipe for WC (see soil page 43).

Gully traps

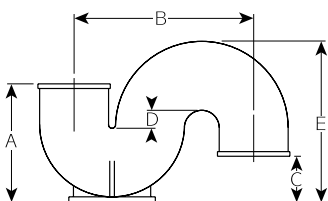
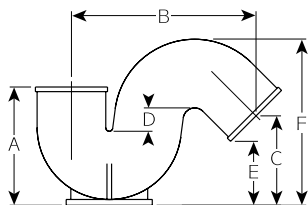
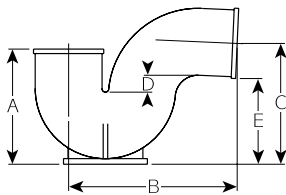

Product code	Dia	A	B	C	D	E	Nominal wt/kg
87½° Gully trap – TD60							
191399	100	205	300	215	50	165	12.4
191400	150	295	400	295	50	220	24.4

Product code	Dia	A	B	C	D	E	F	Nominal wt/kg
45° Gully trap – TD60								
191398	100	205	320	155	50	120	275	13.2

Product code	Dia	A	B	C	D	E	Nominal wt/kg
Vertical gully trap – TD60							
191397	100	205	310	80	50	275	13.2

†Made to order.

Gully traps

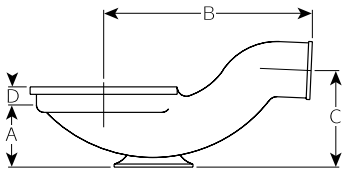

Product code	Dia	A	B	C	D	Nominal wt/kg
87½° Gully trap with 225mm inlet – TD64						
191401	100	130	450	220	43	24.0

Can be used with raising pieces – TD678 and TD108/TD111.

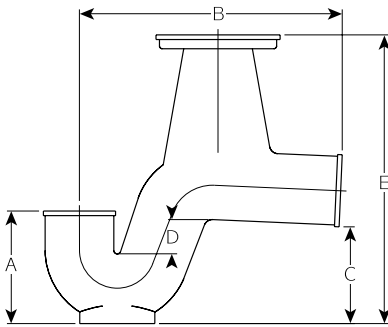

Product code	Dia	A	B	C	D
87½° Gully trap with surface access – TD107					
191402	100	195	455	230	75

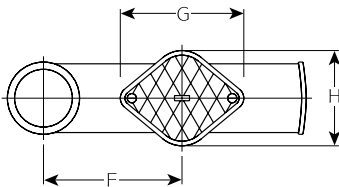

	Dia	E	F	G	H	Nominal wt/kg
87½° Gully trap with surface access – TD107						
	100	500	240	215	165	23.3

Gully inlets bellmouth

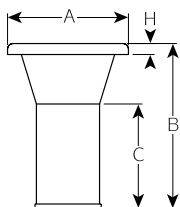

Product code	Dia	A	B	C	H	Nominal wt/kg
Gully inlet • Plain – TD500						
191301	100	220	300	190	17	8.6

Can be used with gratings and covers – TD612/TD616 and raising pieces – TD525.

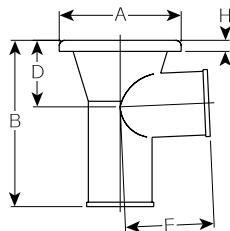

Product code	Dia	Branch	A	B	D	E	H	Nominal wt/kg
Gully inlet with single branch – TD105								
191299	100	100	220	300	120	160	17	11.8

Can be used with gratings and covers – TD612/TD616 and raising pieces – TD525.

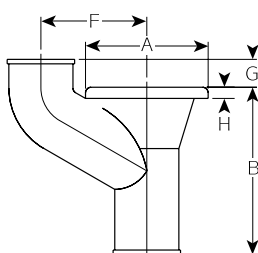

Product code	Dia	Branch	A	B	F	G	H	Nominal wt/kg
Gully inlet with vertical branch – TD106								
191300	100	100	220	300	190	50	17	13.7

Can be used with gratings and covers – TD612/TD616 and raising pieces – TD525.

Raising pieces

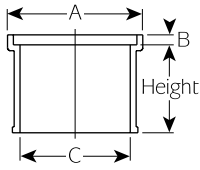

Product code	Height	A	B	C	Nominal wt/kg
Raising piece – TD525					
191303	150	220	17	190	9.1
191305	305	220	17	190	11.3

To suit Bellmouth – TD500/TD105/TD106.
 Can be used with gratings and covers – TD612/TD616.
 Raising pieces require caulking into above listed components.
 See p35 for details on caulking compound.

Gratings and covers

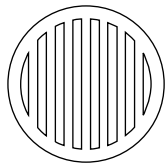

Product code	Dia	Nominal wt/kg
Grating plain – TD612		
191385	200	1.8

Maximum load 2.0 tonnes.

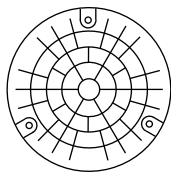

Product code	Dia	Nominal wt/kg
Solid cover – TD613S		
191386	200	2.0

Maximum load 2.0 tonnes.

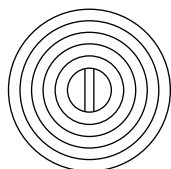

Product code	Dia	Nominal wt/kg
Grating hinged and locking – TD614		
191387	200	1.8

Maximum load 2.0 tonnes.

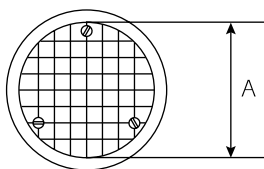

Product code	Dia	A	Nominal wt/kg
Sealed plate and frame – TD615			
191388	200	180	2.7

Maximum load 2.0 tonnes. Sealed with rubber seal three screws.

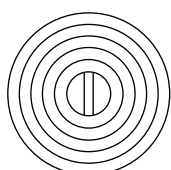

Product code	Dia	Nominal wt/kg
Grease sealed cover and frame – TD616		
191389	200	2.2

Maximum load 2.0 tonnes. Three screws to fix.

TD612/TD616 can be used in conjunction with raising pieces – TD525.
 Bellmouths – TD500/TD105/TD106 and clearing arm bends – TD425.
 Gratings – TD614/TD615/TD616 require caulking into above listed components. See p35 for details on caulking compound.

Gully traps

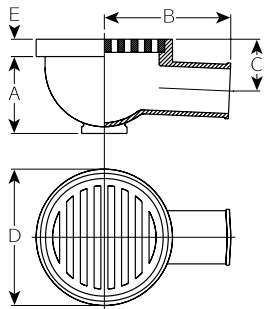

Product code	Dia	A	B	C	D	E	Nominal wt/kg
87½° Trapless gully trap • 230 diameter inlet – TD467							
191403	100	225	280	130	305	43	17.7

Can be used with raising pieces – TD678 and TD108/TD111.
Can be fitted with covers and gratings – TD650/TD653 and TD661/TD662.

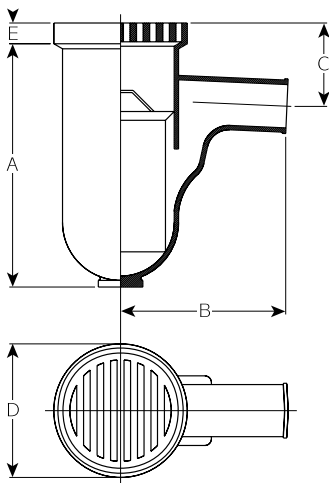

Product code	Dia	A	B	C	D	E	Nominal wt/kg
87½° Deans gully trap • 230 diameter inlet – TD550							
191407	100	560	380	190	305	43	55.4

Can be used with raising pieces – TD678 and TD108/TD111.
Can be fitted with covers and gratings – TD650/TD653 and TD661/TD662.
Can be supplied with Galvanised Sediment Pan: product code 191181.
If used with Galvanised Sediment Pan this fitting can only be fitted with TD650 or TD651 gratings.

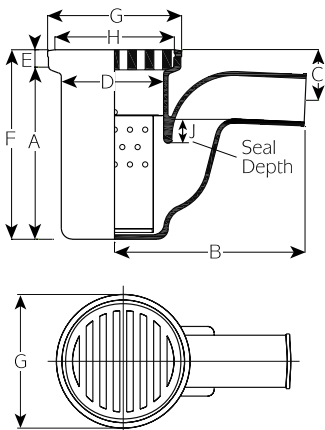

Product code	Dia	A	B	C	D	E	F	G	H	J	Nominal wt/kg
87½° Gully trap • 230 diameter inlet – TD551											
191408	100	395	437	117	225	40	435	308	274	56	30.8

Can be used with raising pieces – TD678 and TD108/TD111.
Can be fitted with covers and gratings – TD650/TD653 and TD661/TD662.
Can be supplied with Galvanised Sediment Pan: product code 191182.
If used with Galvanised Sediment Pan this fitting can only be fitted with TD650 or TD651 gratings.

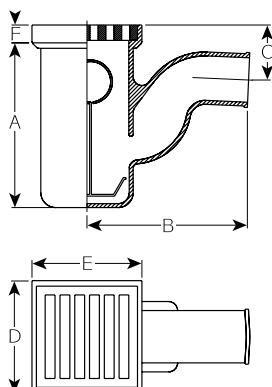

Product code	Dia	A	B	C	D	E	F	Nominal wt/kg
87½° Gully trap • 230 x 230 inlet – TD553								
191381	100	380	370	125	255	250	35	26.8

Can be supplied with Galvanised Sediment Pan: product code 191183.
Can be supplied with Grating: product code 191380.
Maximum load 2.0 tonnes.

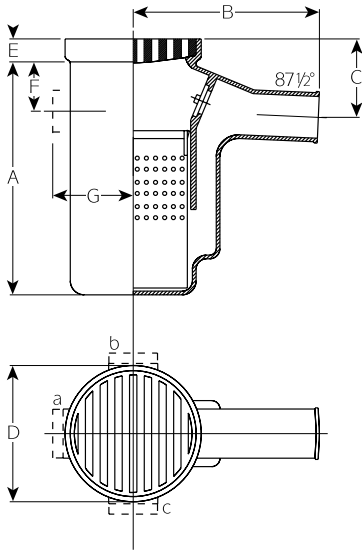

Product code	Dia	A	B	C	D	E	F	G	Nominal wt/kg
87½° Garage gully trap • 305 diameter inlet – TD554									
191410	100	478	363	168	380	67	101	210	58.4

Can be supplied with raising pieces – TD559.

Can be supplied with Galvanised Sediment Pan: product code 191184.

Can be supplied with grating: product code 191382.

Maximum load 7.5 tonnes.

100 Inlets can be cast on in positions a, b, or c to order.

Product code 02712 191411 inlet at a

02715 191414 inlet at b

02716 191415 inlet at c

02713 191412 inlet at a and b

02714 191413 inlet at a and c

191416 Inlets a, b and c.

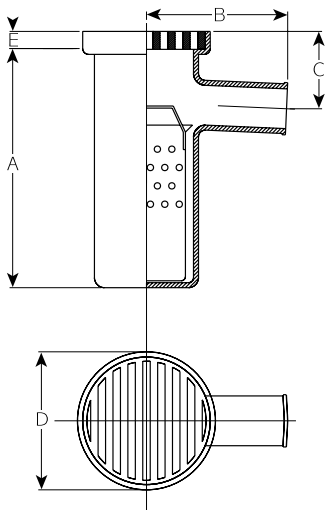

Product code	Dia	A	B	C	D	E	Nominal wt/kg
87½° Trapless gully trap • 230 diameter inlet – TD556							
191409	100	570	335	185	300	45	45.4

Can be used with raising pieces – TD678 and TD108/TD111.

Can be fitted with covers and gratings – TD650/TD653 and TD661/TD662.

Can be supplied with Galvanised Sediment Pan: product code 191181.

If used with Galvanised Sediment Pan this fitting can only be fitted with TD650 or TD651 gratings.

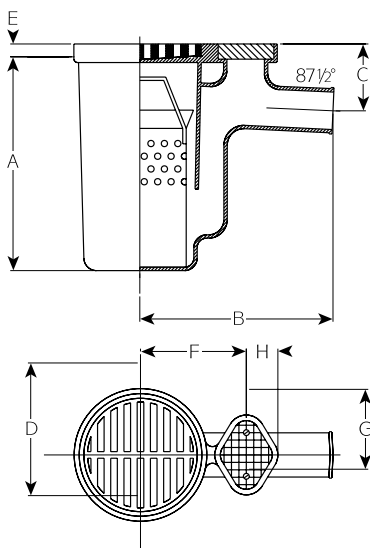

Product code	Dia	A	B	C	D	E	F	G	H	Nominal wt/kg
87½° Garage gully trap • 330 diameter inlet – TD558										
191418	100	560	520	180	405	50	285	215	85	75.5

Can be supplied with Galvanised Sediment Pan: product code 191185.

Can be supplied with Grating: product code 191383.

Maximum load 7.5 tonnes.

Yard gully

Heavy roadway hinged grating and frame.
Grating dished 25mm deep for channel or flat.

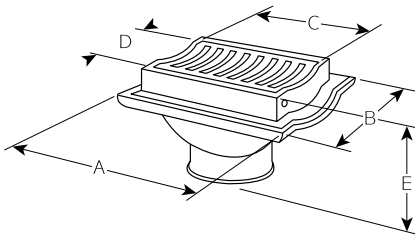

Product code	Outlet dia	A	B	C	D	E	Nominal wt/kg
Gully trap with luting flange – TD561							
191357	225	445	375	335	265	205	44.0

For use with traps – TD550/TD551 and TD556.

Raising pieces – TD678 and TD108/TD111 and tapered inlet gullies – TD684 and TD120/TD123.

Grating maximum load 7.5 tonnes.

Requires caulking into fittings.

See p35 for details on caulking compound.

Running traps

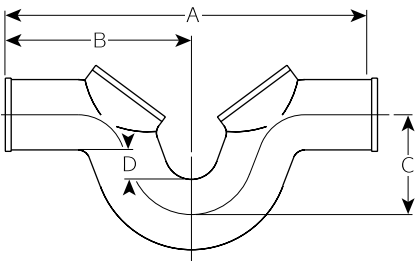

Product code	Dia	A	B	C	D	Nominal wt/kg
Running trap with double access – TD475						
191404	100	413	206	150	50	14.2
191405	150	775	370	215	50	55.4
191406	225	1200	600	325	100	144.0

225 diameter comes supplied with foot.

100 and 150 diameter have round accesses.

225 diameter has rectangular accesses.

Raising pieces

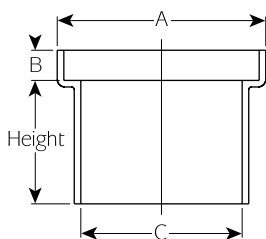

Product code	Height	A	B	C	Nominal wt/kg
Raising piece – TD559					
191354	75	380	50	305	12.7
191356	150	380	50	305	20.4
191355	300	380	50	305	37.0

For use with gully trap – TD554.

Requires caulking into gully trap.

See p35 for details on caulking compound.

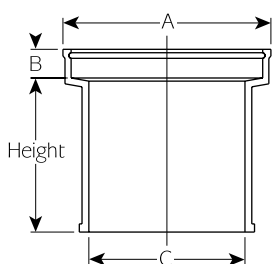

Product code	Height	A	B	C	Nominal wt/kg
Raising pieces • 225 inside diameter • Plain – TD678					
191363	75	305	43	225	9.5
191365	115	305	43	225	11.6
191364	150	305	43	225	13.5
191366	225	305	43	225	17.0
191367	300	305	43	225	21.5

Raising pieces

TD108/111

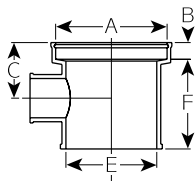

TD108

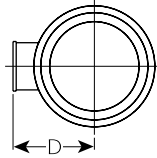

TD111

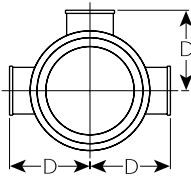

Product code	A	B	C	D	E	F	Nominal wt/kg
Raising piece with 100 inlet branch – TD108							
191347	305	43	140	205	225	225	19.0

Product code	A	B	C	D	E	F	Nominal wt/kg
Raising piece with 100 inlet branches – TD111							
191348	305	43	140	205	225	225	23.1

Raising pieces – TD678 and TD108/TD111 can be used in conjunction with gully traps – TD64/TD467/TD550/TD551/TD556 and tapered gully inlets – TD684 and TD120/123.

Can also be used with grating and covers – TD650/TD653 and TD661/TD662.

Raising pieces require caulking into Gully Traps. See p35 for details on caulking compound.

Tapered gully inlets

TD684

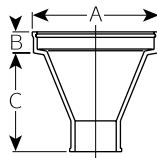

TD120

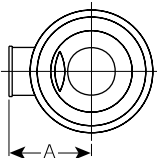
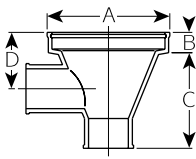

TD123

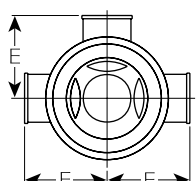

Product code	Outlet dia	A	B	C	Nominal wt/kg
Tapered gully inlet • 225 inside diameter • Plain – TD684					
191368	100	305	43	245	12.9
191369	150	305	43	225	12.3

Product code	Outlet dia	A	B	C	D	E	Nominal wt/kg
Tapered gully inlet with 100 inlet branch – TD120							
191352	100	305	43	245	140	205	14.2

Product code	Outlet dia	A	B	C	D	E	Nominal wt/kg
Tapered gully inlet with 100 inlet branches – TD123							
191353	100	305	43	245	140	205	20.3

Tapered gully inlets – TD684 and TD120/TD123 can be used in conjunction with raising pieces – TD678 and TD108/TD111 and can be used with gratings and covers – TD650/TD653 or TD661/TD662.

Gratings and covers

For gully traps, raising pieces and tapered gully inlets 265 diameter to suit TD678 and TD108/TD111 raising pieces, TD684 and TD120/TD123 tapered gully inlets, and gully traps TD467/TD550/TD551/TD556.

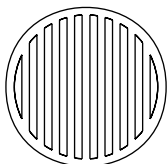

Product code	Dia	Nominal wt/kg
Light grating – TD650		
191390	265	3.6

Maximum load 2.0 tonnes.

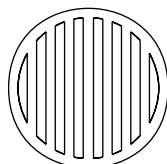

Product code	Dia	Nominal wt/kg
BS heavy grating – TD651		
191391	265	8.0

Maximum load 7.5 tonnes.



Product code	Dia	Nominal wt/kg
Hinged and locking grating and frame – TD653		
191360	265	5.3

Maximum load 2.0 tonnes.

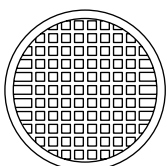

Product code	Dia	Nominal wt/kg
Sealing plate and frame fitted with two screws – TD661		
191361	265	5.0

Maximum load 7.5 tonnes.

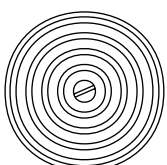

Product code	Dia	Nominal wt/kg
Grease seal cover and frame fitted with two screws – TD662		
191362	265	3.6

Maximum load 2.0 tonnes.

Requires caulking into above listed gully traps, raising pieces and tapered gully inlets. See p35 for details on caulking compound.

Rainwater shoes

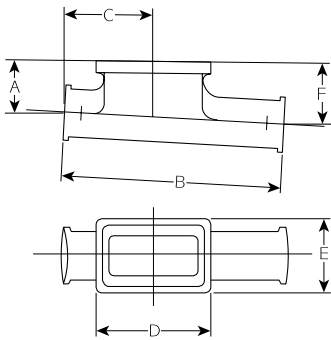

Product code	Dia	A	B	C	D	E	F	Nominal wt/kg
Rainwater shoe with horizontal inlet – TD114								
191349	100	125	530	215	280	180	147	15.5

Can be used with gratings and covers – TD790 to TD795.
Can be used with raising pieces – TD793.

Raising pieces

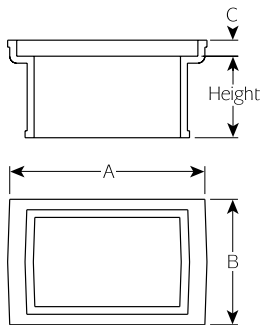

Product code	Height	A	B	C	Nominal wt/kg
Raising piece – TD793					
191378	305	280	180	25	15.4

For use with TD114.
Can be used with gratings and covers – TD790 to TD795.
Raising pieces require caulking into rainwater shoes.
See p35 for details on caulking compound.

Gratings and covers

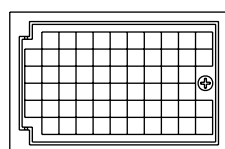
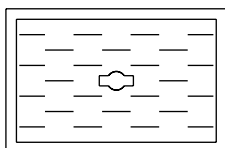
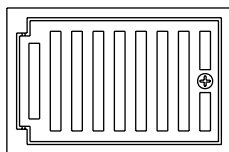
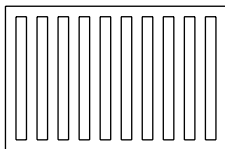

Product code	Dimensions	Nominal wt/kg
Grating – TD790		
191374	240 x 140	2.4

Product code	Dimensions	Nominal wt/kg
Hinged and locking grating and frame – TD791		
191375	240 x 140	3.2

Product code	Dimensions	Nominal wt/kg
Grease seal cover and frame – TD792		
191376	240 x 140	2.4

Fitted with two screws if required.

Product code	Dimensions	Nominal wt/kg
Hinged and locking cover and frame – TD795		
191379	240 x 140	3.2

The above gratings and covers are for use with rainwater (drain) shoes – TD114 and raising pieces – TD793. Gratings – TD791/TD795 require caulking into above listed components. See p35 for details on caulking compound.

Airtight inspection eye covers

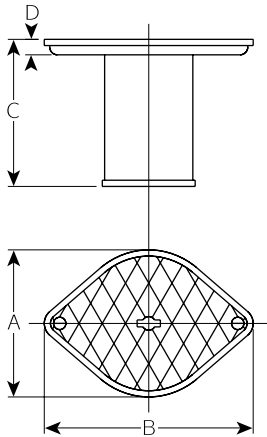

Product code	Dia	A	B	C	D	Nominal wt/kg
Airtight inspection eye covers – TD724						
191394	100	215	270	190	35	10.0
191395	150	260	320	180	30	16.2

Chambers

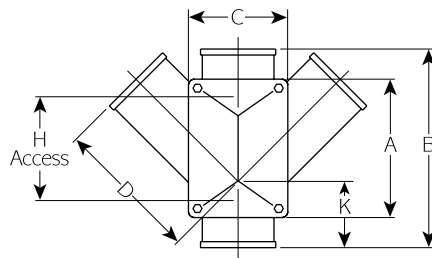
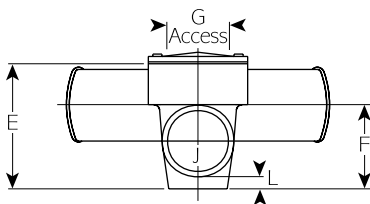

Product code	Dia	A	B	C	D	E	F	G	H	J	K	L	Nominal wt/kg
Chamber • Double branch – TD14													
191306	100 x 100	230	330	165	240	210	140	100	170	65	110	20	19.6
191307	150 x 100	210	300	215	285	250	170	150	150	90	55	25	24.7
191308	150 x 150	285	380	215	330	300	200	150	225	95	105	25	38.6
† 191309	225 x 100	500	910	280	400	370	220	226	450	110	320	62	100.0
† 191310	225 x 150	500	910	280	450	370	220	226	450	85	320	62	110.0
† 191311	225 x 225	500	910	280	565	370	220	226	450	45	320	62	174.0

L and J are dimensions to invert.

† Made to order.

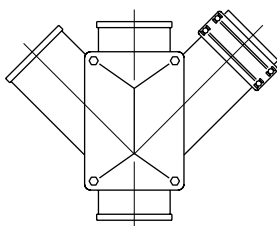

Single branch arm:
if only one branch arm is required,
blank off unused arm using
TD34 Blank End with TD01 coupling.

Chambers

Product code	Dia	A	B	C	D	E	F	G	H	J	K	L	M	N	P	Nominal wt/kg
Chamber – TD17																
191312	100 x 100	560	670	140	250	210	140	100	520	65	160	20	250	55	240	40.2
191313	150 x 100	560	670	190	285	245	165	150	520	90	160	25	250	55	280	55.9
191314	150 x 150	700	810	190	330	300	195	150	660	95	135	25	360	55	335	87.2
† 191315	225 x 100	500	920	280	400	370	220	226	450	110	210	62	250	235	410	210.0
† 191316	225 x 150	1050	1460	280	450	370	220	226	1000	85	320	62	550	235	410	220.0
† 191317	225 x 225	1050	1460	280	565	370	220	226	1000	45	320	62	550	235	410	240.0

L and J are dimensions to invert.

†Made to order.

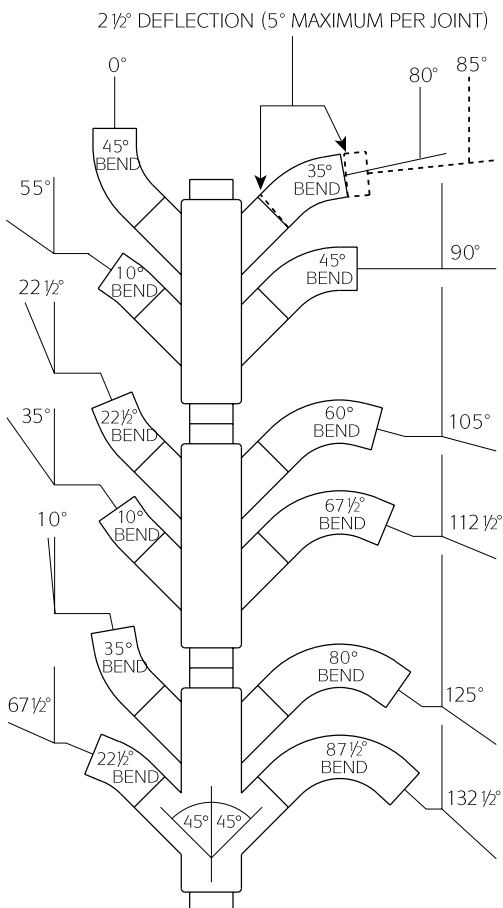
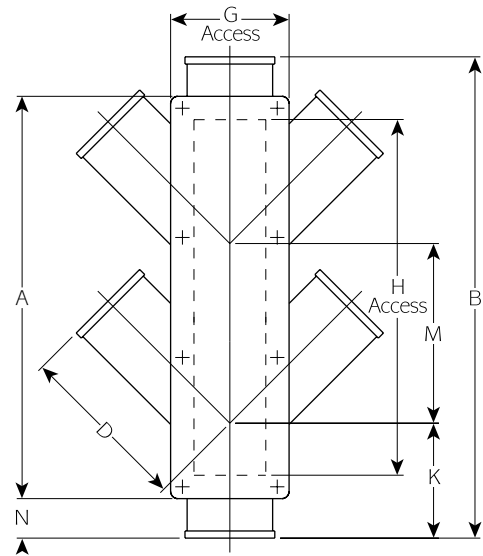
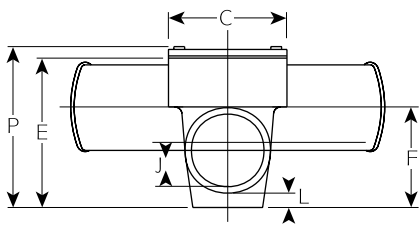

Inspection chambers

Inspection chamber branch arm entries are all at 45° to conform with BS 437 and Codes of Practice BS EN 12056 Parts 2 and 3.

Where other angles of entry are necessary these can be achieved by the use of standard bends as shown. The Timesaver joint having at 5° deflection capability enables other angles to be achieved e.g. 10° gap from 80° to 90° deflect each joint of 35° bend according to angle required. An 85° angle is illustrated.

The diagram assumes that the branch drains have a fall of 1 in 40 or less. Falls steeper than this will alter the bend apparent angle in plan.

†Made to order.

Eureka anti-flooding trunk valves

Jones 'Eureka' anti-flooding trunk valves and interceptors for disconnecting chambers and tidal outfalls.

These valves consist of a cast iron body, stainless steel flap faced with rubber seal, separate cast iron valve seating, polystyrene float fixed to a brass pivot rod, and a bolted cover with rubber seal.

The valve and float are fixed to the same brass spindle in adjoining chambers separated by baffles which allow water to enter but excludes solids. Under normal circumstances the valve hangs clear of the flowing sewage, but when the flood water rises the float rises with it and closes the valve.

When flood water subsides the float falls, the valve is raised and the rush of pent up water cleans the valve.

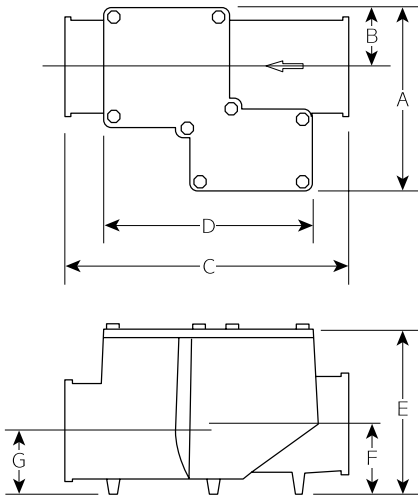

Product code	Dia	A	B	C	D	E	F	G	Nominal wt/kg
Anti-flooding trunk valve 'Eureka' – TD750									
191420	150	330	105	490	365	285	115	105	50.0

100, 225, 300mm diameter are currently available in traditional socket and spigot specification (see page 30).

225 and 300mm diameter are made to order.

Note: 1" BSP float vent is supplied plugged. Plug should be removed and a vent pipe carried upwards to such a height and so positioned as not to transmit foul air in such a manner as to become prejudicial to health or a nuisance. These valves are sold at customers' risk only without guarantee. They are checked before despatch and no liability can be accepted after installation. It is recommended that these valves are serviced before the start of each wet season or a least twice a year.

Ball valve anti-flooding

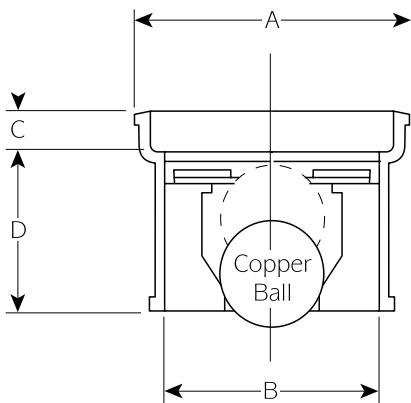

Product code	A	B	C	D	Nominal wt/kg
Anti-flooding ball valve – TD756					
191421	305	225	43	180	21.8

Can be used with grating – TD650.

Can be used in conjunction with TD64/TD467/TD550/TD551/TD678 and TD684.

Not recommended for use in foul drain systems.

This valve is sold at customers' risk only without guarantee.

They are checked before despatch and no liability can be accepted after installation.

It is recommended that these valves are serviced before the start of each wet season or a least twice a year.

Flanges loose puddle

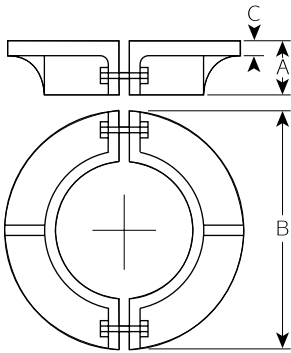

Product code	Dia	A	B	C	Nominal wt/kg
Flange – TD777					
191371	100	50	220	13	3.9
191372	150	65	275	13	5.6
191373	225	65	360	13	8.6

This collar is in two halves which can be bolted around the pipe even when pipe is in position.

Can also be used as a firestop.

Due to manufacturing tolerances it is recommended that the puddle flange is bedded on Denso tape or similar material.

Grease traps

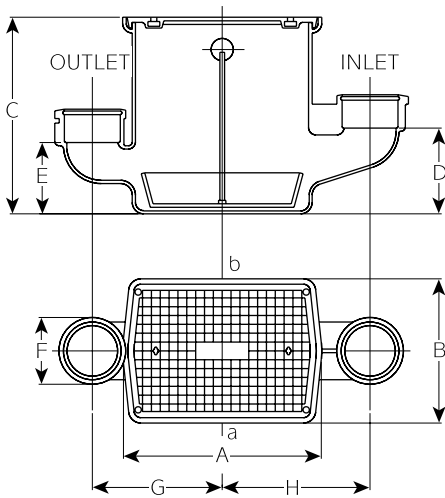

For use inside and outside building.

Inside dimensions for TD706: 455 x 305 x 545.

Product code	Dia	A	B	C	D	E	F	G	H	Nominal wt/kg
Grease trap – TD706 with grease seal cover										
191419	100	545	400	545	250	210	185	360	410	113.1

Single seal cover: product code 191393

Can be used with Galvanised Sediment Pan: product code 191187.

Can be used with Bellmouth – TD105 and TD106 on Inlet.

Can be used with TD708 on outlet.

Can be tapped 1/2" BSPT for vent at a or b to order.

It is recommended that if an appliance, which has its own water seal is connected directly to the grease trap, the waste pipe should be vented and this should be positioned as close to the grease trap as possible.

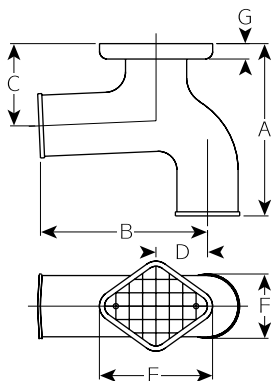

Product code	Dia	A	B	C	D	E	F	G	Nominal. wt/kg
Grease trap outlet for TD706 grease trap – TD708									
191370	100	330	330	155	100	220	175	30	17.1

TRADITIONAL

Inlets

SOCKET AND SPIGOT DRAIN FITTINGS TO BS 437

fresh air

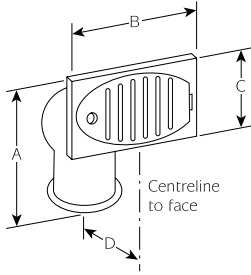
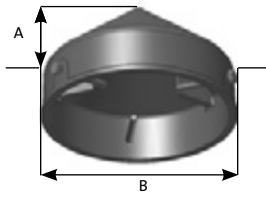
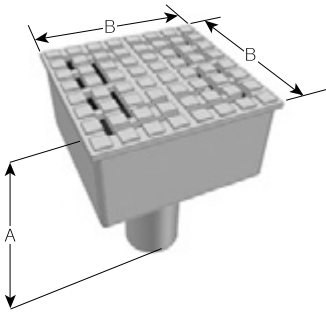

Product code	Dia	A	B	Nominal wt/kg
'CREGEEN' with hinged cover – 585				
191590	100	343	305	22.2

Product code	Dia	A	B	Nominal wt/kg
Ventilating head with three GM screws – 589				
191591	100	178	292	8.8

To fit 100 drain pipe socket or 150 drain pipe spigot.

Product code	Dia	A	B	C	D	Nominal wt/kg
Fresh air inlet – 591						
191592	100	315	255	175	115	10.0

Without flap valve.
With locking grill.

Traps

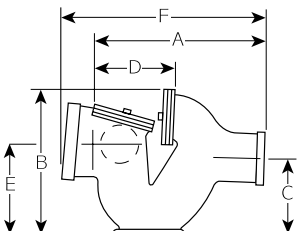
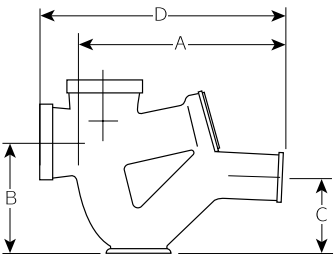
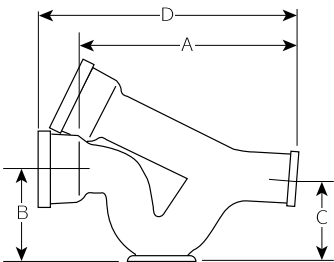

Product code	Dia	A	B	C	D	Nominal wt/kg
Intercepting trap – 477						
191602	100	530	230	220	582	34.0
191603	150	660	300	290	740	66.0

Product code	Dia	A	B	C	D	Nominal wt/kg
Intercepting trap – 479						
191605	100	580	290	220	660	47.0

Product code	Dia	A	B	C	D	E	F	Nominal wt/kg
Intercepting trap – 481								
191607	100	530	240	230	240	235	660	44.0
191610	150	610	485	290	290	320	700	68.0

100 and 150mm dia with 100 dia FAI.

Can be supplied with fresh air inlet LH or RH.

100 LH 191608 100 RH 191609 150 LH 191611 150 RH 191612.

Position of inlet left/right decided when viewing against the direction of the flow. If in doubt – contact Technical Dept. 01952 262529

Eureka anti-flooding trunk valves

Jones 'Eureka' anti-flooding trunk valves and interceptors for disconnecting chambers and tidal outfalls.

These valves consist of a cast iron body, stainless steel flap faced with rubber seal, separate cast iron valve seating, polystyrene float fixed to a brass pivot rod, and a bolted cover with rubber seal.

The valve and float are fixed to the same brass spindle in adjoining chambers separated by baffles which allow water to enter but excludes solids. Under normal circumstances the valve hangs clear of the flowing sewage, but when the flood water rises the float rises with it and closes the valve.

When flood water subsides the float falls, the valve is raised and the rush of pent up water cleans the valve.

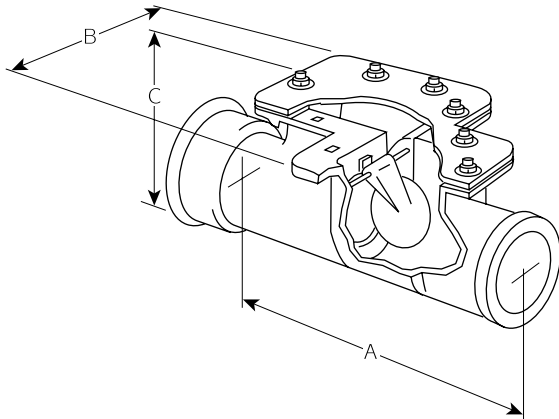

Note: 1" BSP float vent is supplied plugged. Plug should be removed and a vent pipe carried upwards to such a height and so positioned as not to transmit foul air in such a manner as to become prejudicial to health or a nuisance. These valves are sold at customers' risk only without guarantee. They are checked before despatch and no liability can be accepted after installation. It is recommended that these valves are serviced before the start of each wet season or a least twice a year.

Product code	Dia	A	B	C	Nominal wt/kg
Anti-flooding trunk valve 'Eureka' - 750					
191593	100	597	356	241	51.0
+191594	225	889	610	406	120.0
+191870	300	1035	748	540	350.0

150mm diameter (see page 27).

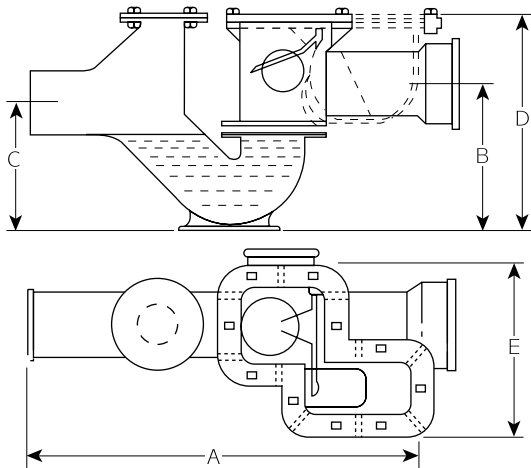

Product code	Dia	A	B	C	D	E	Nominal wt/kg
Anti-flooding trunk valve 'Eureka' - 752							
+191595	100	845	299	267	396	343	105.0
+191596	150	978	355	305	546	406	145.0
+191597	225	1372	559	432	800	584	-

Note: 1" BSP float vent is supplied plugged. Plug should be removed and a vent pipe carried upwards to such a height and so positioned as not to transmit foul air in such a manner as to become prejudicial to health or a nuisance. These valves are sold at customers' risk only without guarantee. They are checked before despatch and no liability can be accepted after installation. It is recommended that these valves are serviced before the start of each wet season or a least twice a year.

Ball valve anti-flooding

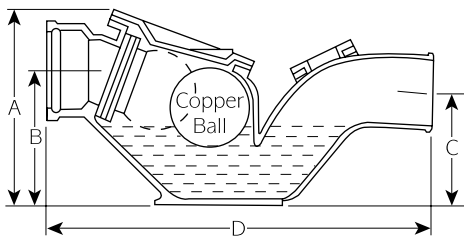

Product code	Dia	A	B	C	D	Nominal wt/kg
Anti-flooding ball valve – 755						
† 191598	100	350	240	185	660	53.5
† 191599	150	460	315	260	820	98.9
† 191600	225	616	438	383	1219	–

Not recommended for use in foul drain systems.

These valves are sold at customers' risk only without guarantee.

They are checked before despatch and no liability can be accepted after installation.

It is recommended that these valves are serviced before the start of each wet season or a least twice a year.

These valves should be set horizontally with the aid of a spirit level.

† Made to order.

BIM Library



Saint-Gobain PAM UK launched the first phase of its fully integrated parametric BIM library in 2014. The Timesaver ranges will be added by end of 2015.

The Saint-Gobain PAM BIM library has been produced on the guidelines and frameworks defined by the UK standards documents, including BS1192:2007, PAS1192-2, and BS8541-1 & BS8541-2:2011

The BIM library of components has been designed up to LOD Specification level 350. Compatibility:

- From 2012 Autodesk REVIT (.rvt)

Access to the BIM library will be available through the Saint-Gobain website www.saint-gobain-pam.co.uk or contact the PAM BIM technical consultant on 01952 262561.

Design recommendations

Trench preparation

Timesaver drain may be laid directly into a naturally trimmed trench allowing 50mm clearance at each joint between coupling and trench bottom. The trench bottom should be flat to give continuous support to the pipework.

If the subsoil can't be accurately trimmed with a spade, the trench should be excavated to a depth of 100mm below the pipe invert and a granular bed laid. This also should allow 50mm clearance at each joint between the coupling and the granular bed. Where Timesaver drain is to be set in concrete, the trench should be prepared as described above to allow a minimum of 100mm of concrete under the pipe.

The pipe should be supported on a compressible material (e.g. expanded polystyrene), either side of each joint. The concrete should have a suitable flexible joint at intervals not greater than 5m in order to reduce the natural rigidity of the concrete. This should be made of a compressible material (e.g. expanded polystyrene), which should be placed next to a pipe joint, and conform to the full cross section of the concrete (see Fig. 1).

Haunching and surround should not be carried out until the pipework has been tested and inspected.

Differential movement

Timesaver couplings allow up to 5° deflection at each joint.

Pipelines leaving buildings, manholes or other structures which are likely to be subject to settlement, should have a minimum of two joints a maximum of 600mm apart, thereby allowing a short length of pipe to act as a 'rocker pipe'. The joint nearest the structure should be as close to it as possible and in areas where large settlement is expected, more than one 'rocker pipe' may be required (see Fig. 2).

Minimum depth of pipework

Timesaver drain can be installed with a minimum cover of 75mm under building without further protection. Where Timesaver drain is installed under roads and yards, subject to normal usage, protection need only be considered if the cover is less than 300mm. However, in areas that are subject to special loadings or abuse, extra protection should be considered.

Minimum bedding – limits of cover

The choice of bedding and backfilling depends on the depth at which the pipes are to be laid and the size and strength of the pipes. Rigid pipes like cast iron are more robust than flexible plastics pipes and backfilling can therefore be simpler. The Building Regulations specify the limits of cover for rigid pipes as follows:

Limits of cover for standard strength rigid pipes in any width of trench (as per BS EN 752)

Pipe size	Bedding class	Fields and gardens		Light traffic roads		Heavy traffic roads	
		Min metres	Max metres	Min metres	Max metres	Min metres	Max metres
100	D or N	0.4	4.2	0.7	4.1	0.7	3.7
	F	0.3	5.8	0.5	5.8	0.5	5.5
	B	0.3	7.4	0.4	7.4	0.4	7.2
150	D or N	0.6	2.7	1.1	2.5	–	–
	F	0.6	3.9	0.7	3.8	0.7	3.3
	B	0.6	5.0	0.6	5.0	0.6	4.6

Backfill sequence

Trenches should be backfilled in stages, and at least 150mm of earth free from stones larger than 40mm, lumps of clay over 100mm and vegetable matter should cover the pipe before tamping down. Further 300mm thick layers of selected fill should be tamped down until the trench is full.

Falls

Pipework gradients should be chosen to obtain a self-cleaning action under normal discharge conditions. For flows of less than 1 litre/sec a gradient of 1 in 40 for 100mm pipe and 1 in 60 for 150mm pipe, are usually sufficient and for practical purposes, the gradients should not be less than 1 in 80 for 100mm pipe and 1 in 150 for 150mm pipe.

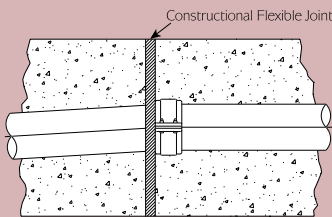

Fig. 1

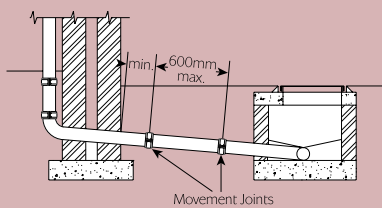
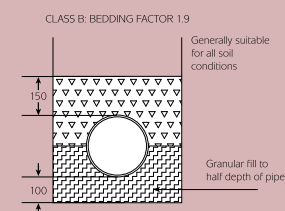
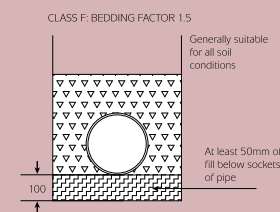
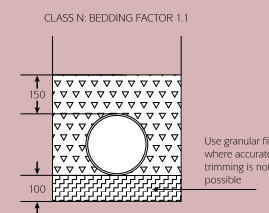
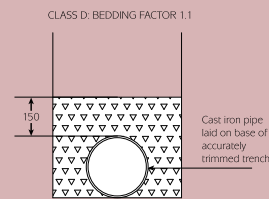

Fig. 2

Backfilling for rigid pipes



Design recommendations

Access

Access is required on all pipelines to facilitate the rodding and clearing of debris and can be provided by manholes, chambers, access fitting or rodding eye – the latter allowing downstream access only.

Generally, no part of a drain should be further from a manhole than 45m and the distance between manholes should not exceed 90m (see Fig. 3).

Where a drain connects with another drain without the provision of an inspection chamber or manhole, access should be provided on the branch drain within 12m of the junction (see Fig. 4 and Fig. 5).

It is recommended that access to the pipework is installed each time the drain changes direction either horizontally or vertically by the inclusion of an access fitting (see Fig. 6 and Fig. 7).

Inspection chambers

Inspection chamber branch arm entries are all at 45° to conform with BS 437 and BS EN 12056 Parts 2 and 3.

Where other angles of entry are necessary these can be achieved by the use of standard bends as shown above. The Timesaver joint having at 5° deflection capability enables other angles to be achieved, e.g. 10° gap from 80° to 90° deflect each joint of 35° bend according to angle required. An 85° angle is illustrated (see Fig. 10).

The diagram assumes that the branch drains have a fall of 1 in 40 or less. Falls steeper than this will alter the bend apparent angle in plan.

Use of bends

Bends in drains should be kept to a minimum. Wherever possible bends should be at or near to manholes or in a position which will allow ease of rodding (see Fig. 8).

At the base of soil and rainwater stacks, it is recommended that long or large radius bends be used (see Fig. 9).

Use of branches

Branches or junctions on drains should be, where possible, at access points, such as manholes, to facilitate rodding.

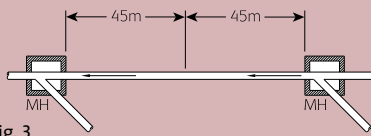

Fig. 3

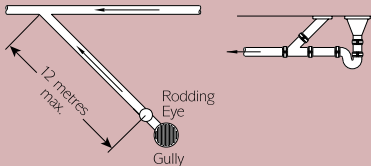

Fig. 4 + 5

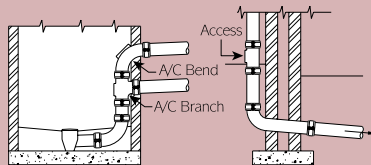

Fig. 6 + 7

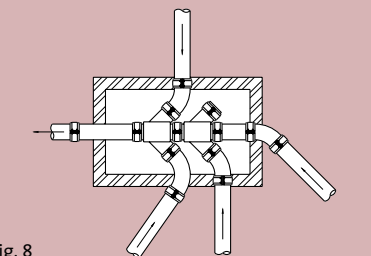

Fig. 8

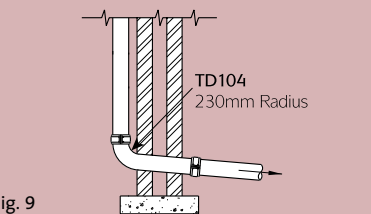

Fig. 9

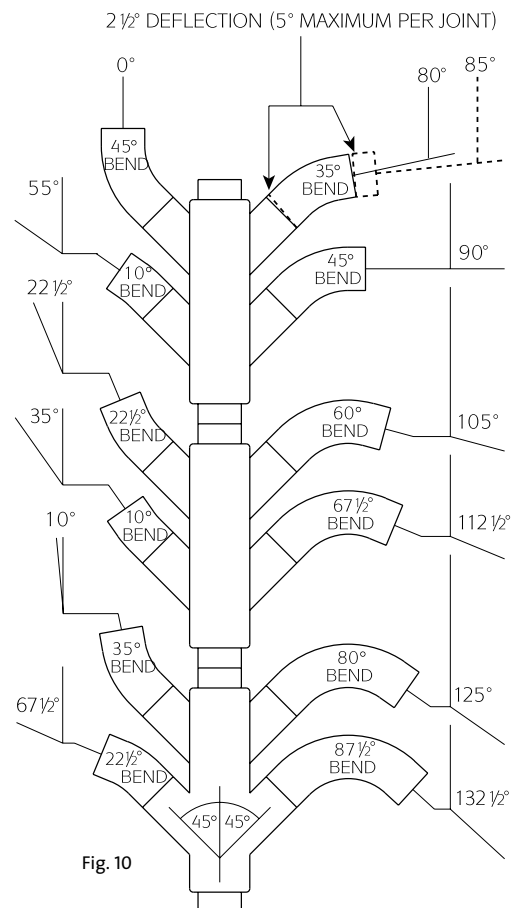

Fig. 10

Design recommendations

TD777

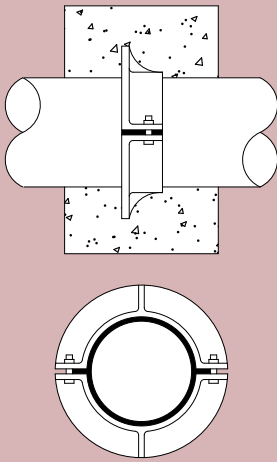

Fig. 11

Gullies, floor drains and traps

A drainage gully is a fitting that enables wastewater to enter the drainage system without allowing smells or sewer gases to escape. A variety of designs have been developed to suit different situations, for example – back inlet gully, which is used to connect rainwater pipes and waste pipes from ground floor sinks.

Ventilation of drains

It is important to allow a passage of air through the drainage system to enable any foul gases to escape. This is achieved by providing air inlets at the low point and vent pipes that terminate at high level, and also at the head of the drain. Convection currents cause a slow flow of air through the system. Also, if the air pressure in the drain was reduced, say by the pipes flowing full, the trap seals of gullies and WC's would be lost and the sewer gases would be able to enter the building.

Puddle flanges

Where pipes pass through external walls, a puddle flange may be required to prevent water from entering where the pipe is below the natural ground water table, or methane gas from entering the building from made-up ground. Loose, two-piece flanges should be bedded onto 'Denso' tape and tightened into position (see Fig. 11).

Support recommended for suspended drainage

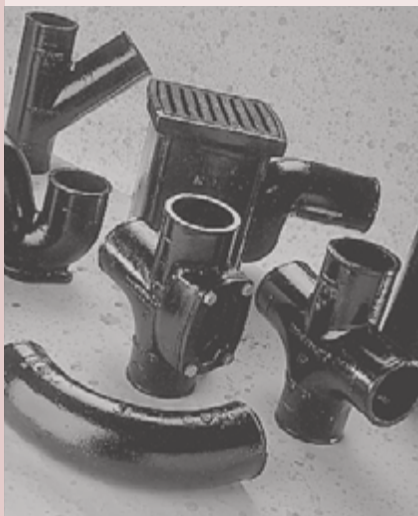

It is important that all suspended horizontal pipework is adequately supported by brackets and fixings of sufficient strength to support the pipes and their maximum contents.

The distance between pipe supports should not exceed 3m (BS EN 12056-2 Code of Practice for Sanitary Pipework'). However, as shown in Fig. 12, it is recommended that suspended BS 437 pipes should have two bracket supports per 3m length.

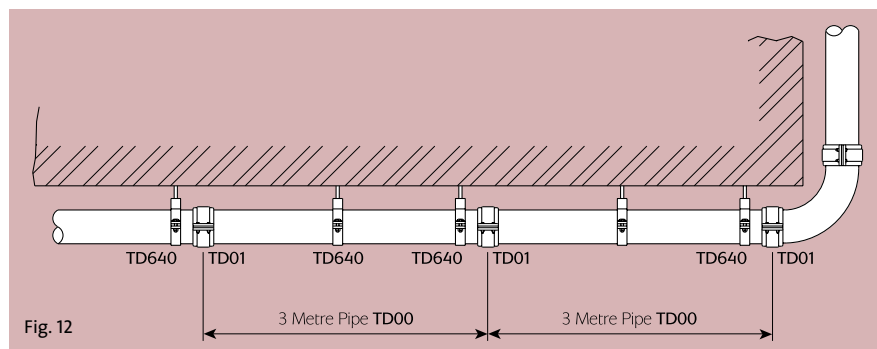
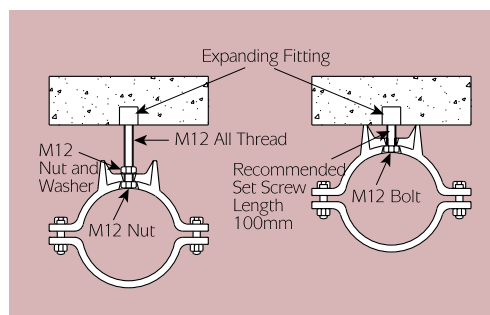

Fig. 12



Connection to other systems

A. Timesaver drain dimensions

Most materials can be connected to Timesaver drain by using a TD01 coupling if their dimensions conform to the following table:

Timesaver drain nominal dia	Min o/dia	Max o/dia
100	116	119
150	170	173
225	250	256

or by using a TD02 coupling if their dimensions conform to the following table:

Timesaver drain nominal dia	Min o/dia	Max o/dia	Other material
100	110	114	
150	161	165	

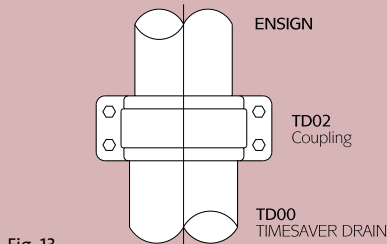

Fig. 13

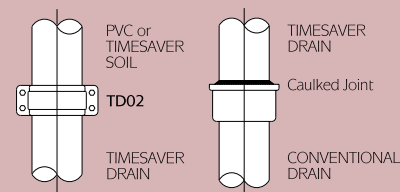

Fig. 14

Fig. 15

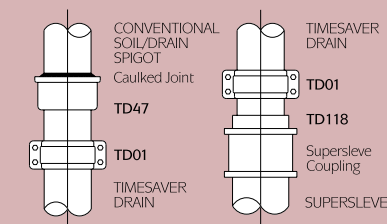

Fig. 16

Fig. 17

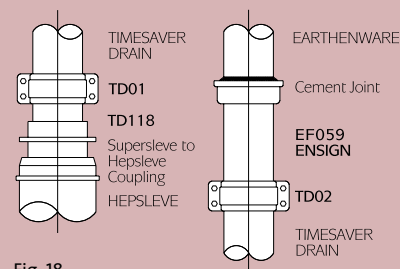

Fig. 18

Fig. 19

B. Ensign

Couple directly to Ensign using a TD02 transitional coupling (see Fig. 13). Four bolt, two piece coupling to BS 6087.

C. Timesaver soil

Timesaver soil can be connected directly to Timesaver drain using a TD02 coupling (see Fig. 14).

D. Conventional drain/soil

To connect Timesaver drain/soil into a conventional drain socket use a traditional caulked joint (see Fig. 15).

If connecting to a conventional drain/soil spigot use a TD47 with a caulked joint and a TD01 at the spigot of the TD47 (see Fig. 16).

E. Hepworth clayware

100 and 150 Supersleve can be connected to Timesaver drain by using a TD118 adaptor and a TD01 coupling (see Fig. 17).

100 and 150 Hepsleve can be connected to Timesaver Drain by using a TD118 adaptor and a TD01 coupling in conjunction with a Supersleve to Hepsleve transitional coupling manufactured by Hepworth (see Fig. 18).

F. Earthenware

Timesaver drain can be connected to an earthenware socket using a traditional cement joint.

If connecting to an earthenware spigot use a EF059 and a TD02 coupling with a traditional cement joint at the socket of the EF059 (see Fig. 19).

Advice on cold caulking

For products which require to be caulked ie socketed BS437 fittings or raising pieces we recommend the following:

Resin product code: W251A

Hardener product code: W252

Supplied by:
John Winter & Co. Ltd
Foundry & Dental Supplies
P.O. Box 21
Washer Lane Works
Halifax
HX2 7DP

Tel: 01422 364 213 Fax: 01422 330 493



All pipes, fittings and couplings are subjected to tests in accordance with the requirements of the relevant British Standard prior to despatch from works.

Pipes and fittings

A. Hydrostatic test

Pipes and fittings, after coating, conform to the hydrostatic pressure requirements of BS 437:

Pipes	345kPa	(3.45 Bars)
Fittings	170kPa	(1.70 Bars)

The test pressure is applied internally and maintained for not less than 15 seconds and up to a maximum of one minute.

B. Crushing test

Pipes and, where applicable, fittings conform to the BS 437 requirements of being capable of withstanding a test load of 150kN per metre run.

Couplings

A. Deflection test procedure

Fully engage pipe ends into joint assembly. Align them axially with one pipe restrained from movement and the other pipe completely free to move. Separate the pipes axially by 5mm on either side of central register.

Angularly deflect one pipe with respect to the other, to an angle of 3° with the fulcrum on the centre line of the pipes within the joint. Apply and maintain a hydrostatic pressure of 1 bar for period of five minutes without leakage.

B. Drain testing

It is normal practice to carry out two soundness tests on drainage systems. The first, before back filling the trench, followed by a second test after back filling which may be required to be witnessed by the local building control officer.

Methods of testing – two methods of soundness testing are possible: a water test or an air test.

Water test – to carry out a water test the length of drain to be tested is blocked off at its lower end by means of a drain stopper. Another stopper is fitted at the top of the run of drain with an up-stand pipe of 1.5m height attached. The drain is then filled with water and the joints can then be inspected for leaks. It is recommended that the total head of water should not exceed 4m so it may be necessary to test the drain in sections.

Air test – the air test is quicker to carry out and more searching than the water test, and should be used in preference. To carry out the test, drain stoppers are fitted to any open ends, and gullies have their traps filled with water. A length of hose is then passed through a trap and air is gently blown into the drain until a pressure of 100mm is indicated on a manometer. Provided a pressure of at least 75mm remains after 5 minutes of the test, the drain can be considered sound. Where traps or gullies are connected the drain should withstand a pressure of 50mm water gauge and this should not fall by more than 12.5mm in a 5-minute period.

C. Straight draw test procedure

Fully engage the pipes in the joint assembly, as Fig. 20. Align them axially. Separate the pipes axially by 5mm on either side of the central register. Prevent further longitudinal movement. Apply and maintain a hydrostatic pressure of 1 bar for a period of five minutes without leakage.

D. Shear loading test procedure

Fully engage the pipes in the joint assembly and align them axially on supporting structure, as Fig. 21. Separate the pipes axially by 5mm on either side of central register. Prevent further longitudinal movement. Apply a shear load of 0.025kN x nominal pipe diameter in mm, inclusive of the mass of the pipe and contents, uniformly over a length of 300mm adjacent to the coupling, as Fig. 21.

Apply and maintain a hydrostatic pressure of 1 bar for a period of five minutes without leakage.

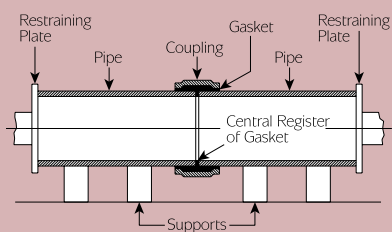

Fig. 20

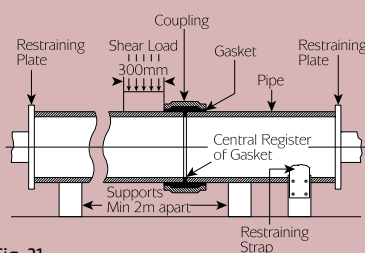

Fig. 21

It is recommended that these technical notes should be read in conjunction with the following British Standards:

1. BS EN 12056-2: Code of Practice for Sanitary Pipework (inside the building).
2. BS EN 12056-3: Code of Practice for Drainage of Roofs and Paved Areas (inside the building).
3. BS EN 752: Drains and Sewers Outside Buildings.
4. BS 8301: Code of Practice for Building Drainage (now obsolete).

Section 2

Soil Pipes and Fittings



Joining method



- A. Pipe or fitting
- B. Pipe or fitting
- C. Synthetic rubber gasket
- D. Coupling
- E. Set screws and nuts

50, 75 and 100 diameter couplings have two set screws and nuts. 150 couplings have four set screws and nuts.

Couplings are supplied ready assembled

1. Slacken bolts to fullest extent.
2. Place synthetic rubber gasket on end of pipe or fitting A, and slide loosely assembled coupling over pipe B.
3. Fit pipe B into gasket ensuring both A and B are butting against the internal central register.
4. Slide coupling over gasket ensuring that it is centrally located and tighten bolts alternately so that the gap between coupler halves is even on both sides. When hand tight check alignment of assembly.
5. Complete tightening operation by use of a Ratchet Spanner – EF100 with Deep Socket – EF101 until a suitable resistance is achieved (min 20Nm).

Joints may be deflected up to 5° without affecting the sealing properties. The Timesaver couplings meet the performance requirements of BS 6087:1990 and incorporate synthetic rubber gaskets conforming to BS EN 681-1/ISO 4633 and set screws and nuts. A Ratchet Spanner – EF100 is the recommended tool required to tighten the set screws which give a 'for all time seal' water and airtight installation.

Saint-Gobain PAM UK does not accept liability for any complaints on installations where components not manufactured by Saint-Gobain PAM UK are included.

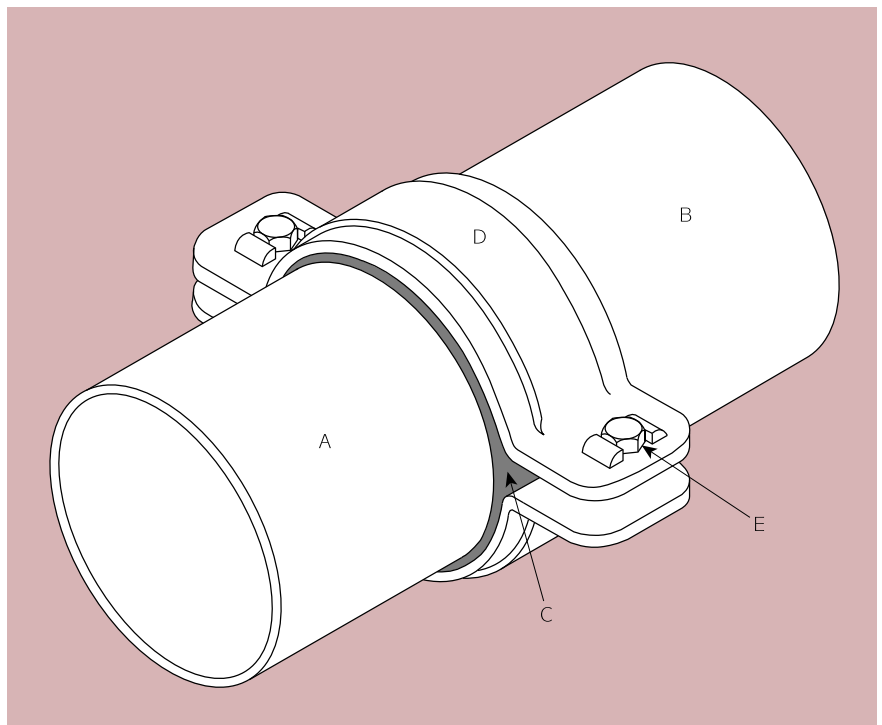

Electrical continuity

Designed for use in situations where equipotential bonding (earthing) has been specified, the Timesaver electrical continuity clips are available for use with Timesaver soil and Timesaver drain systems.

The Timesaver electrical continuity clip fits a standard Timesaver coupling. Only one electrical continuity clip is required per coupling. Note: The electrical continuity test should be carried out in accordance with BS 6087.

Continuity clips

These are supplied separately to the coupling in standard quantity bags of 25 number.

Coupling	Product code	Ref no.
To suit 50, 75, 100, GT01	191189	GT965
To suit 150 GT01, 100, 150TD01	191190	GT96L
To suit 100 TD02	191191	GT96T
To suit 150 TD02	191192	GT96T6
To suit 225 TD01	191193	GT968

Assembly instructions:

1. Slacken bolts to fullest extent.
2. Place synthetic rubber gasket C on pipe or fitting A and slide loosely assembled coupling over pipe B.
3. Fit pipe B into gasket ensuring both A and B are butting up to central register.
4. Fit continuity clip D centrally by peeling back one edge of the gasket and slipping it into the Continuity clip.
5. Repeat for other edge of gasket, so the gasket is held within the continuity clip D.
6. Position clip at 90° to gasket ears and in the direction of the pipe run.
7. Slide coupling over gasket and tighten bolts alternately so that the gap is even on both sides. When hand tight check alignment.
8. Complete tightening operation by use of a ratchet spanner – EF100 and deep socket – EF101 (min 20Nm).

Note: Use one continuity clip per coupling joint. Continuity clip must not be reused after tightening.

The installation should be tested to BS EN 12056 for a soil installation or to BS EN 752 for a drain installation and to IEE Regulations on equipotential bonding (earthing).

Provided that the Timesaver electrical continuity coupling is assembled and installed as recommended in our instructions, and the pipework is bonded to the main electrical earth or similar earth, it is considered that the Timesaver electrical continuity coupling will satisfy the IEE Regulations.

It is recommended that the installation is regularly checked for equipotential bonding (earthing) in case of accidental damage, unauthorised pipework modifications, etc.

If a Timesaver electrical continuity installation is to be modified for any reason Timesaver electrical continuity couplings must be used and the installation re-tested for equipotential bonding (earthing).



Pipes double spigot

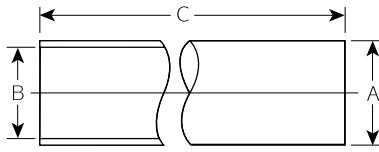

Product code	Nom dia	A Max o/dia	B Min i/dia	Min section	C Metre lengths available	Wt per mt kg
Pipe – GT00						
156366	50	63	50	4	3	6.4
156456	75	89	75	4	3	8.3
156567	100	112	101	4	3	9.3
156831	150	165	152	4	3	15.7

Pipes are internally lined with a two part epoxy paint (ochre colour).
Externally coated with black acrylic paint and stencilled every metre with silver marking.

Pipes double spigot – Heritage

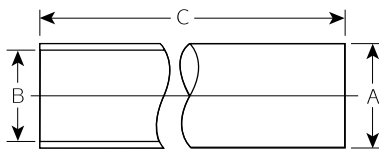

Product code	Nom dia	A Max o/dia	B Min i/dia	Min section	C Metre lengths available	Wt per mt kg
Pipe – GT00 – Timesaver Heritage						
192423	100	112	101	4	1.8	9.3
206854	75	89	75	4	1.8	8.3

1.8 (6ft) pipe coated internally/externally in a black water based primer, for use with Timesaver Heritage couplings.

Brackets

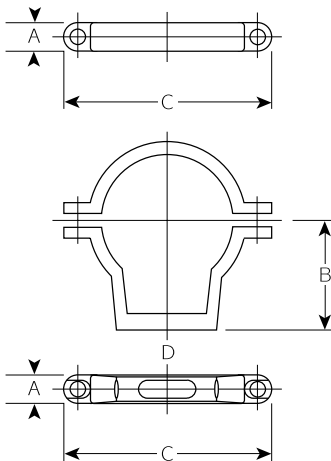

Product code	Dia	A	B	C	Nominal wt/kg
Ductile iron bracket • Elongated slot at fixing point (D) to ease fixing – GT48					
191720	50	27	64	110	0.3
191721	75	27	75	140	0.5
191722	100	27	90	166	0.6
191723	150	30	115	214	0.8

50-100 brackets suit M10 fixing.
150 bracket suit M12 fixing.

Can be fitted with a new acoustic dampener for exceptional sound deadening performance (see page 55).
Contact technical department 01952 262529 for information.

Tools

EF100

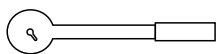

EF098

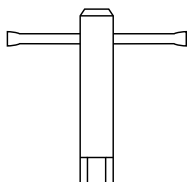

Ratchet spanner – EF100: product code 191201

A ratchet spanner is the recommended tool required to tighten the set screws, used in conjunction with a deep socket – EF101: product code 191202.

'T' box spanner – EF098: product code 191200

13mm A/F, dual purpose, for use with Timesaver and Ensign systems.

Couplings

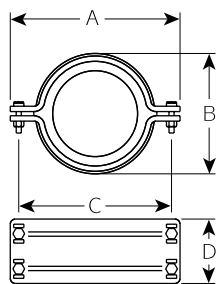
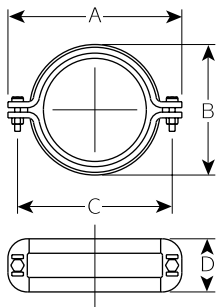
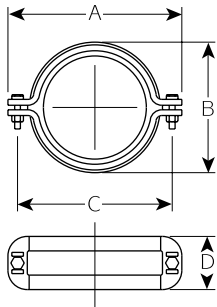

Standard

Ductile iron coupling with synthetic rubber gasket for jointing Timesaver soil to Timesaver soil (black gasket).

Product code	Dia	A	B	C	D	*E	Nominal wt/kg
Two-piece ductile iron coupling – GT01							
191691	50	126	85	105	55	5	0.8
191692	75	158	110	130	55	5	1.0
191693	100	185	135	160	55	5	1.4
191694	150	250	190	220	75	5	2.8

Two set screws are supplied on 50, 75, 100 couplings.

Four set screws are supplied on 150 couplings.

Electrical continuity clips are available supplied separately in standard quantity bags (see ref table page 39).

* Minimum allowance (E) to accommodate gasket register (for guidance only).

Transitional

Ductile iron coupling with synthetic rubber gasket for jointing Timesaver soil to conventional soil (black gasket with identity marking).

Product code	Dia	A	B	C	D	*E	Nominal wt/kg
Two-piece ductile iron coupling – GT12							
191695	65-75	158	110	130	55	5	1.0
191429	†70-75	158	110	130	55	5	1.0
191696	90-100	185	135	160	55	5	1.4

Two set screws are supplied on GT12 couplings.

Designed for connecting:

65 (2½") conventional soil to 75 Timesaver soil.

90 (3½") conventional soil to 100 Timesaver soil.

† Connects 75mm Timesaver soil with 70mm Ensign.

* Minimum allowance (E) to accommodate gasket register (for guidance only).

Allowable pipe diameters when using the GT12 coupling

Coupling	Conventional pipe dia.		Timesaver pipe dia.	
	Min.	Max.	Min.	Max.
65-75	72	76	85	89
90-100	97	101	110	114

For connection to other materials see page 56.

Transitional

Ductile iron coupling with stainless steel nuts and set screws and synthetic rubber gasket for jointing Timesaver drain to Timesaver soil (black gasket with identity marking).

Product code	Dia	A	B	C	D	*E	Nominal wt/kg
Two-piece ductile iron coupling – TD02							
191297	100	203	140	180	75	5	2.8
191298	150	252	195	230	75	5	3.6

Four set screws are supplied on TD02 couplings.

Electrical continuity clips are available supplied separately in standard quantity bags (see ref table page 39).

* Minimum allowance (E) to accommodate gasket register (for guidance only).

Heritage couplings

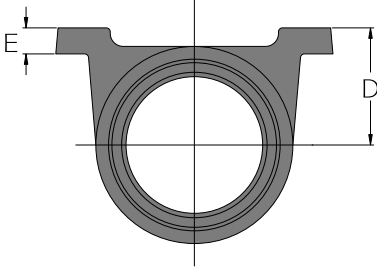
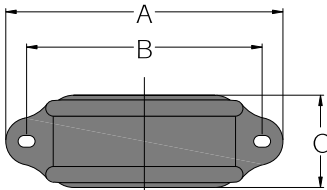
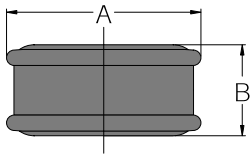

Reducing Gasket

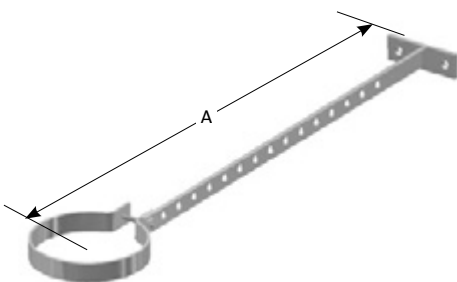

Product code	Dia	A	B	Nominal wt/kg
Joint • Plain no ears – GT05P				
192418	50	99	73	0.9
206855	75	128	73	1.4
192421	100	152	73	1.8

Product code	CAD Ref	Dia	A	B	C	D	E	Nominal wt/kg
Joint • With fixing ears – GT05E								
192417		50	146	114	73	62	20	1.4
206856		75	178	146	73	76	20	2.0
192420		100	213	181	73	90	20	2.6

Product code	Dia	A	B	C	D	E	Nominal wt/kg
Joint • Slip – GT05S with reduced central register							
192419	50	146	114	73	62	20	1.4
206836	75	178	146	73	76	20	2.0
192422	100	213	181	73	90	20	2.6

To connect Timesaver Heritage couplings – 100mm diameter to 90mm traditional soil utilise reducing gasket: product code 156132 (see page 58).

Product code	Dia	Nominal wt/kg
Cast iron wall spacer		
192424	50	0.2
206838	75	0.2
192425	100	0.3

To suit eared PFJ GT05E.

Product code	Dia	Nominal. wt/kg
Mild steel restraining bracket – EF053		
192333	100	0.5

To suit 100mm Timesaver Heritage coupling with ears GT05E.

Product code	Dia	A	Nominal wt/kg
Mild steel restraining bracket – EF053A			
192363	100	450	0.5

To suit 100mm diameter Timesaver Heritage pipework (see page 59 for typical installation).

Pipes transitional

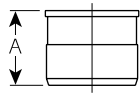

Product code	Dia	A	Nominal wt/kg
Adaptor from Timesaver drain to supersleve – TD118			
191350	100	100	2.2
191351	150	125	5.1

Use in conjunction with TD02 connect to Timesaver soil to supersleve.

Connectors WC

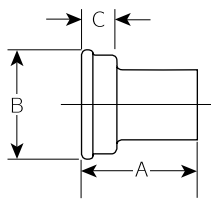

Product code	Dia	A	B	C	Nominal wt/kg
Transitional EF059					
156650	100	155	176	80	2.9

To connect, earthware, WC, stoneware, traditional, soil/drain etc.
Note: Ensign product red epoxy coated.

Bends short radius

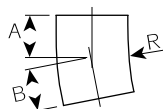
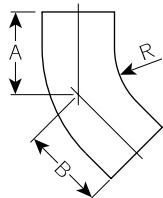
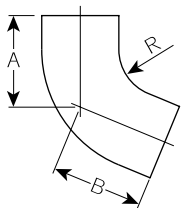
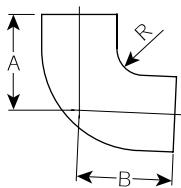

Product code	Dia	A	B	R	Nominal wt/kg
87½° Bend • Short radius – GT02					
191620	50	115	115	40	1.4
191622	75	135	135	40	2.9
191631	100	145	145	40	2.3
191634	150	145	145	15	3.9

Product code	Dia	A	B	R	Nominal wt/kg
67½° Bend • Short radius – GT02					
191625	100	135	135	70	4.0

Product code	Dia	A	B	R	Nominal wt/kg
45° Bend • Short radius – GT02					
191619	50	50	50	15	0.6
191621	75	115	115	70	2.3
191626	100	135	135	150	3.5
191632	150	90	90	15	3.0

Product code	Dia	A	B	R	Nominal wt/kg
11° Bend • Short radius – GT02					
191628	100	35	55	30	1.6

Bends long radius

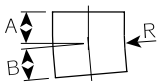
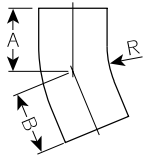
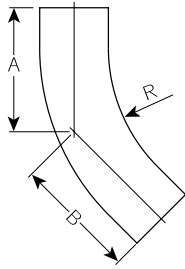
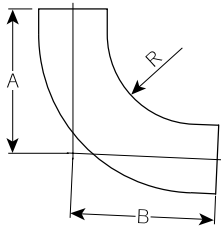

Product code	Dia	A	B	R	Nominal wt/kg
87½° Bend • Long radius – GT02L					
191623	75	230	230	150	4.5
191630	100	269	269	180	4.3
191635	150	274	274	150	10.1

Product code	Dia	A	B	R	Nominal wt/kg
45° Bend • Long radius – GT02L					
191627	100	205	205	275	6.1

Product code	Dia	A	B	R	Nominal wt/kg
22½° Bend • Long radius – GT02L					
191624	100	90	90	180	1.7
191633	150	140	140	150	4.8

Product code	Dia	A	B	R	Nominal wt/kg
5° Bend • Long radius – GT02L					
191629	100	50	50	230	1.5

Bends short radius with oval access doors

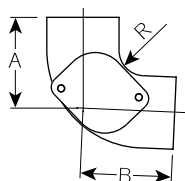
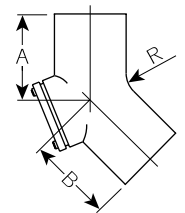
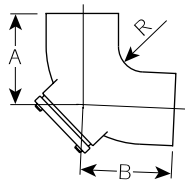

Product code	Dia	A	B	R	Nominal wt/kg
87½° Bend with access rear • Short radius – GT03					
191636	50	115	115	40	1.9
191638	75	135	135	40	3.6
191642	100	145	145	40	3.3
191644	150	145	145	15	6.1

Product code	Dia	A	B	R	Nominal wt/kg
45° Bend with access rear • Short radius – GT03					
191637	75	115	115	70	3.5
191640	100	130	130	120	5.0
191643	150	150	150	120	7.4

Product code	Dia	A	B	R	Nominal wt/kg
87½° Bend with access side • Short radius – GT04					
191646	100	145	145	40	4.8

Bends

medium and long radius with oval access doors

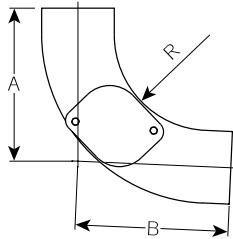
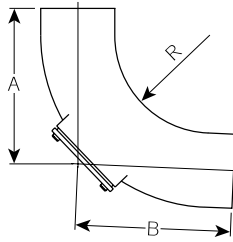

Product code	Dia	A	B	R	Nominal wt/kg
87½° Bend with access rear • Long and medium radius • GT03L					
191639	75	230	230	150	5.3
191641	100	269	269	180	7.4
191645	150	274	274	150	11.7

Product code	Dia	A	B	R	Nominal wt/kg
87½° Bend with access side • Long radius – GT04L					
191647	100	250	250	180	7.4

Bends long tail

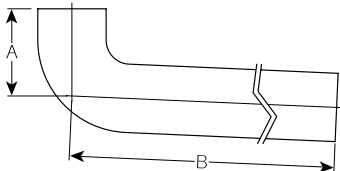
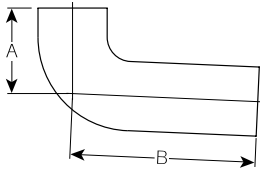

Product code	Dia	A	B	Nominal wt/kg
87½° Bend • Long tail – GT43				
191688	100	110	250	4.6

Product code	Dia	A	B	Nominal wt/kg
87½° Bend • 815 long tail – GT55				
191689	100	165	815	13.9

Branches

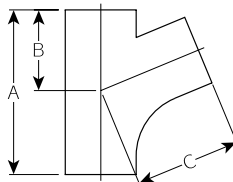
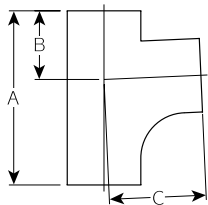

Product code	Dia	A	B	C	Nominal wt/kg
87½° Branch – GT06					
191649	50 x 50	145	66	80	1.0
191651	75 x 50	205	75	125	2.6
191653	75 x 75	245	85	145	3.2
191655	100 x 50	204	90	120	2.4
191657	100 x 75	245	90	145	4.1
191660	100 x 100	270	102	150	3.5
191662	150 x 100	300	117	202	7.6
191664	150 x 150	375	145	215	10.7

Product code	Dia	A	B	C	Nominal wt/kg
67½° Branch – GT06					
191658	100 x 100	265	130	170	5.0

Branches

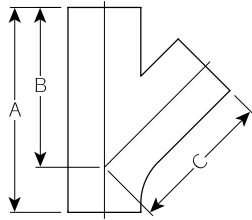

Product code	Dia	A	B	C	Nominal wt/kg
45° Branch – GT06					
191648	50 x 50	185	135	135	1.4
191650	75 x 50	250	190	170	3.5
191652	75 x 75	285	220	185	4.5
191654	100 x 50	200	165	165	2.4
191656	100 x 75	290	225	210	4.9
191659	100 x 100	275	205	205	3.8
191661	150 x 100	295	240	240	6.1
191663	150 x 150	355	265	265	9.0

Branches double

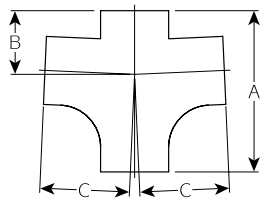

Product code	Dia	A	B	C	Nominal wt/kg
87½° Double branch – GT10					
191681	75 x 75	245	85	145	4.7
191683	100 x 100	270	102	150	4.2
191684	150 x 100	300	115	200	10.9

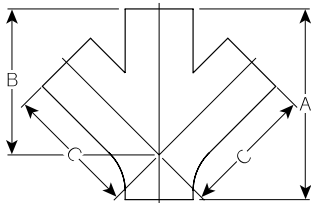

Product code	Dia	A	B	C	Nominal wt/kg
45° Double branch – GT10					
191682	100 x 100	260	190	190	4.0

Branches with access doors

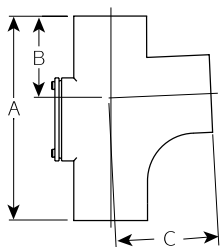

Product code	Dia	A	B	C	Nominal wt/kg
87½° Branch with access rear – GT07					
191665	50 x 50	195	75	110	2.4
191666	75 x 50	205	75	125	3.7
191668	75 x 75	245	85	145	4.2
191670	100 x 50	204	90	120	3.0
191672	100 x 75	245	90	145	5.3
191674	100 x 100	270	102	150	4.3
191676	150 x 100	300	117	202	10.4
191678	150 x 150	400	140	260	13.9

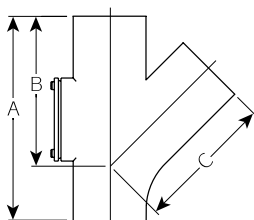

Product code	Dia	A	B	C	Nominal wt/kg
45° Branch with access rear – GT07					
191673	100 x 100	320	245	220	7.6
191675	150 x 100	370	305	255	10.8

Branches with oval access doors

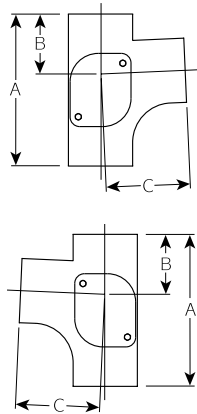

Product code	Dia	A	B	C	Nominal wt/kg
87½° Branch with access right – GT08					
191679	100 x 100	270	100	150	6.6

Product code	Dia	A	B	C	Nominal wt/kg
87½° Branch with access left – GT09					
191680	100 x 100	270	100	150	6.6

Branches double with oval access doors

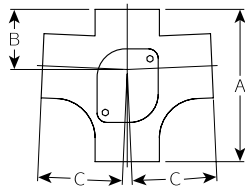

Product code	Dia	A	B	C	Nominal wt/kg
87½° Double branch with access door – GT11					
191685	100 x 100	265	109	150	7.0

Branches 915 long

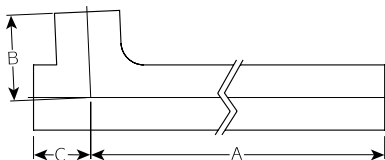

Product code	Dia	A	B	C	Nominal wt/kg
87½° Branch • 915 long tail – GT56					
191690	100	815	165	100	15.0

Branches parallel

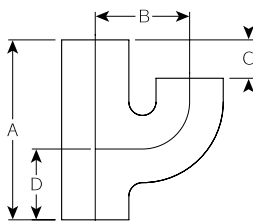

Product code	Dia	A	B	C	D	Nominal wt/kg
Branch • Parallel – GT32						
191686	100 x 100	305	160	65	125	7.4

Branches corner

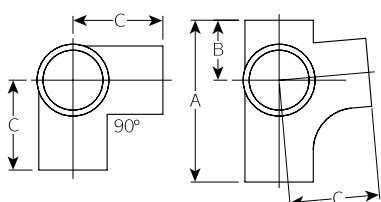

Product code	Dia	A	B	C	Nominal wt/kg
87½° Branch • Corner – GT35					
191687	100 x 100	270	100	150	6.2

Pipes access

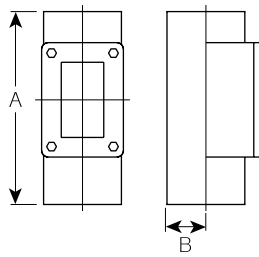
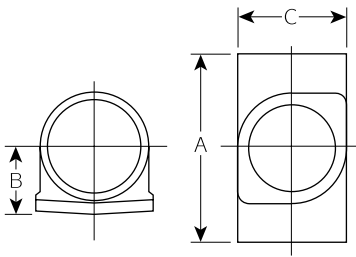

Product code	Dia	A	B	C	Nominal wt/kg
Pipe with oval access door – GT14					
191697	75	280	100	90	4.1
191698	100	250	80	116	3.1
191699	150	280	110	170	6.2

Product code	Dia	A	B	Nominal wt/kg
Pipe with rectangular access door – GT15				
191700	100	320	80	6.7
191701	150	395	105	12.2

Offsets

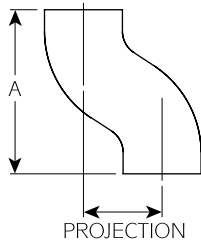

Product code	Dia	A	Nominal wt/kg
Offsets – GT24			
75 Projection			
191702	75	200	2.2
191705	100	215	2.9
115 Projection			
191704	75	220	3.2
191709	100	235	3.4
150 Projection			
191703	75	235	3.5
191706	100	250	4.4
230 Projection			
191707	100	280	5.0
305 Projection			
191708	100	310	6.1

Pipes taper

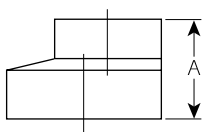

Product code	Dia	A	Nominal wt/kg
Pipes • Diminishing – GT28			
191710	75 x 50	70	0.8
191711	100 x 50	80	0.9
191712	100 x 75	80	1.0
191713	150 x 100	105	1.9

Blank ends

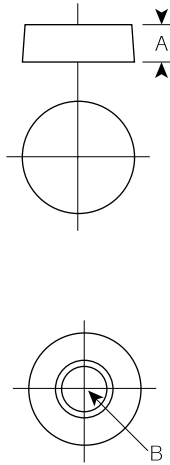

Product code	Dia	A	Nominal wt/kg
Blank ends – GT70			
191724	50	30	0.4
191725	75	35	0.8
191726	100	40	0.8
191727	150	50	2.0

Product code	Dia	A	Nominal wt/kg
Blank ends – GT71			
191728	75	35	0.8
191729	100	40	1.0
191731	150	50	2.0

B – Push-fit adaptor to accommodate 54/56mm o/dia PVC/copper waste.
Note: 50 x 56mm connector available (see Ensign product code 155759).

Blank ends – GT71T drilled and tapped 50mm BSPT			
191730	100	40	1.0

Traps 'P'

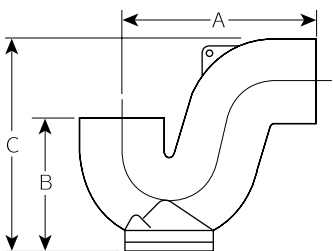
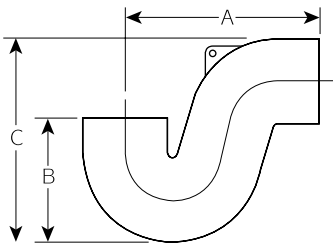

Product code	Dia	A	B	C	Nominal wt/kg
'P' trap • Plain – GT34					
191714	100	255	160	263	4.5

Product code	Dia	A	B	C	Nominal wt/kg
'P' trap with access bottom – GT37					
191715	50	160	115	167	2.0
191716	75	265	210	203	6.3
191717	100	255	175	270	5.2
191718	150	350	240	370	12.1

50mm and 75mm do not have support lug as shown on drawing.

Connectors roof

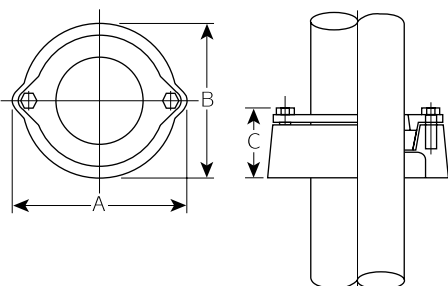

Product code	Dia	A	B	C	Nominal wt/kg
Roof connectors for asphalt – GT73					
191733	100	185	170	72	2.1

Flanges loose puddle

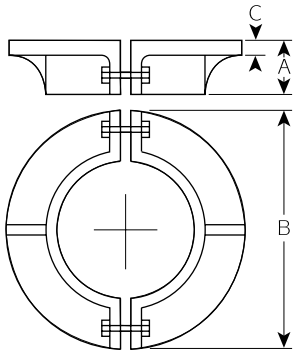

Product code	Dia	A	B	C	Nominal wt/kg
Flange – ED078 supplied grey epoxy coated only					
191829	100	50	220	12	4.6

This collar is in two halves which can be bolted around the pipe even when pipe is in position. Can also be used as a firestop. Due to manufacturing tolerances it is recommended that the puddle flange is bedded on Denso tape or similar.

Gully inlets Bellmouth

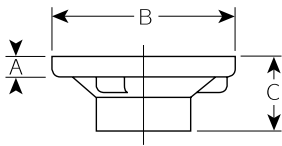

Product code	Dia	A	B	C	Nominal wt/kg
Gully inlet – GT483					
191737	100	25	215	90	2.5

Gratings and covers

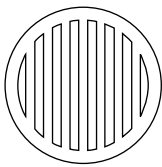

Product code	Dia	Nominal wt/kg
Grating plain – TD612		
191385	200	1.8

Maximum load 2.0 tonnes.

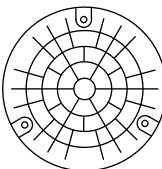

Product code	Dia	Nominal wt/kg
Solid cover – TD613S		
191386	200	2.0

Maximum load 2.0 tonnes.



Product code	Dia	Nominal wt/kg
Grating hinged and locking – TD614		
191387	200	1.8

Maximum load 2.0 tonnes.

Grease trap

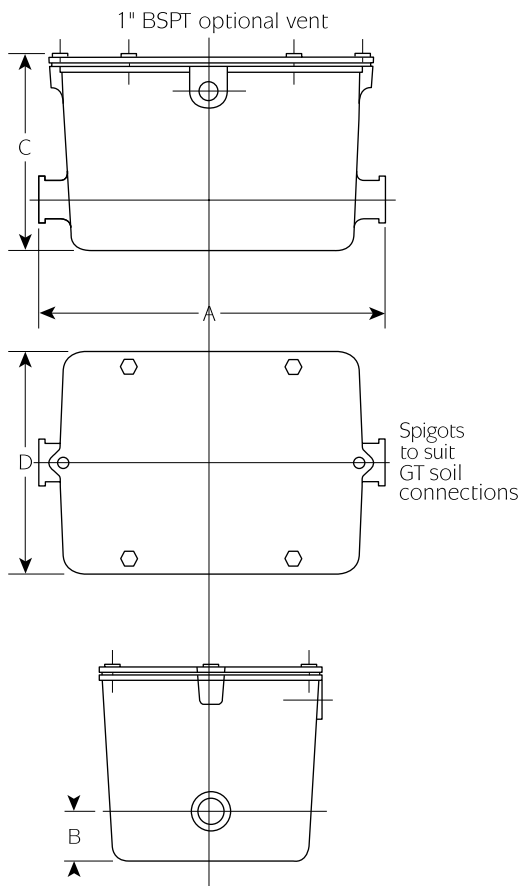

Product code	Dia outlet/inlet	A	B	C	D	Nominal wt/kg
Grease trap – GT707 with sealed cover fitted with six hexagonal set screws						
191734	50	580	85	330	365	60.0

Inside measurements (approx only) 450 x 300 x 300.

Can be supplied with Galvanised Sediment Pan: product code 191188.

Can be tapped 1" BSPT for optional vent.

The cover incorporates a synthetic rubber gasket to seal.

Recommendations regarding the location of the grease trap

1. Grease traps should be installed, whenever possible, well away from areas where food is prepared or cooked.
2. The GT707 grease trap involves manual maintenance i.e. emptying of grease build-up inside the trap, and therefore if overlooked, could possibly become blocked. It is recommended that waste disposal units are not allowed to discharge into the grease trap.
3. It is important that waste from vegetable peelers etc, is filtered prior to entering the trap.
4. Care should be taken that the trap is not located so as to cause inconvenience during manual maintenance.
5. As individual situations differ, it is not possible to specify an optimum distance between the last fixture and the trap this is influenced by the type of discharge, its temperature, rate of flow etc. It is, however, recommended that not more than 6m of pipework should run from the last fixture.

Maintenance

It is recommended that as the GT707 grease trap requires manual maintenance, the trap should be emptied of collected grease waste a minimum of twice per week, after initial installation, which should be adjusted in line with grease build up in the trap. It is recommended that maintenance is carried out at least once a month.

Where would you use it?

The GT707 grease trap has been widely used in kitchens, hospitals, hotels, restaurants and processing plants throughout the country.

Boss branches

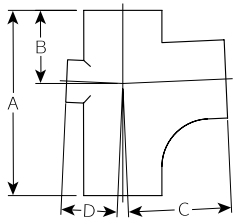

Product code	Dia	A	B	C	D	Nominal wt/kg
87½° Boss branch • Back – GT06						
191743	100 x 100	270	100	150	75	5.4

Available with 50mm BSPT boss only.

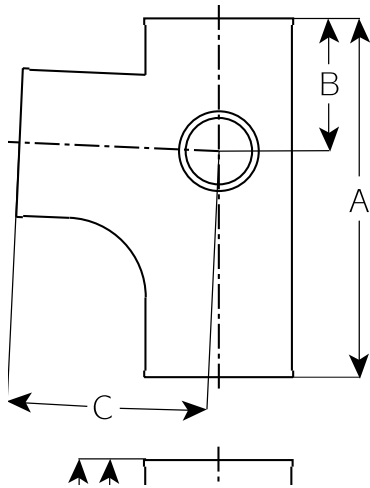

Product code	Dia	A	B	C	D	Nominal wt/kg
87½° Boss branch • Left hand – GT06						
191744	100 x 100	270	100	150	75	5.4

Available with 50mm BSPT boss only.

Product code	Dia	A	B	C	D	Nominal wt/kg
87½° Boss branch • Right hand – GT06						
191745	100 x 100	270	100	150	75	5.4

Available with 50mm BSPT boss only.

Boss pipes

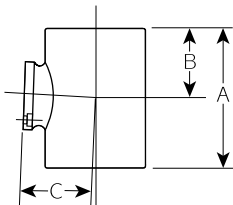

Product code	Dia	A	B	C	Nominal wt/kg
Boss pipe • Single 'O' ring rubber compression boss – GT106					
192236	50	150	75	55	1.2
192237	100	155	75	75	2.1
192239	150	175	87	105	3.8

Boss pipe • Drilled • Tapped 50mm BSPT

191739	75	150	75	63	2.0
192238	100	155	75	75	2.1

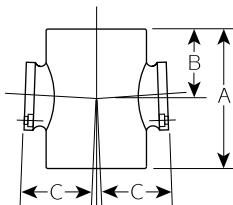

Product code	Dia	A	B	C	Nominal wt/kg
Boss pipe • Double 'O' ring rubber compression boss (opposed) – GT109					
192240	100	155	75	75	2.5
192360	150	175	87	105	4.2

100mm Boss pipe • Drilled • Tapped 50mm BSPT available upon request.

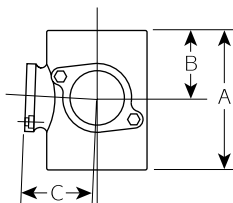

Product code	Dia	A	B	C	Nominal wt/kg
90° Boss pipe • Double 'O' ring rubber compression boss – GT115					
192241	100	155	75	75	2.5

100mm boss pipe • Drilled • Tapped 50mm BSPT available upon request.

Boss pipes

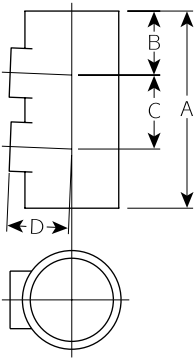

Product code	Dia	A	B	C	D	Nominal wt/kg
87½° Boss pipe – GT132						
191742	100	240	75	90	75	4.1

50mm push-fit connections.

Strap-on boss fitting

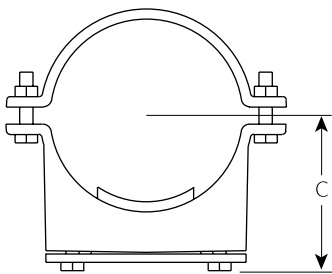
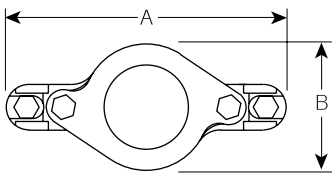

Product code	Dia	A	B	C	Nominal wt/kg
Strap-on boss – GT133					
192323	100	166	76	100	1.4

Insertion depth = 30mm.

The strap-on boss provides a simple solution for fitting a 50mm copper or waste pipe to an existing 100mm cast iron soil pipe to BS 416 (pipe outside diameter min/max 109/114mm).

Installation

- Simply determine where the waste pipe is to be positioned.
- Cut a 64mm hole into the cast iron soil pipe with a hole saw (the metal from the hole remains in the cutter – see tools below).
- Mechanically fit the boss strap in position (do not forget the rubber washer) tighten until fully secure.
- Insert in the waste pipe until fully seated in the boss.
- Tighten the boss plate to grip the rubber 'O' ring on the outside of the waste pipe.

Tools required

- A 64mm hole saw: Product code 192326.
- Arbour: Product code 192327.
- ¼" pilot drill: Product code 192328.
- 13mm socket EF101: Product code 191202.
- or
- 13mm spanner for mechanically fitting the boss adaptor EF098: Product code 191200.



Support for vertical pipework

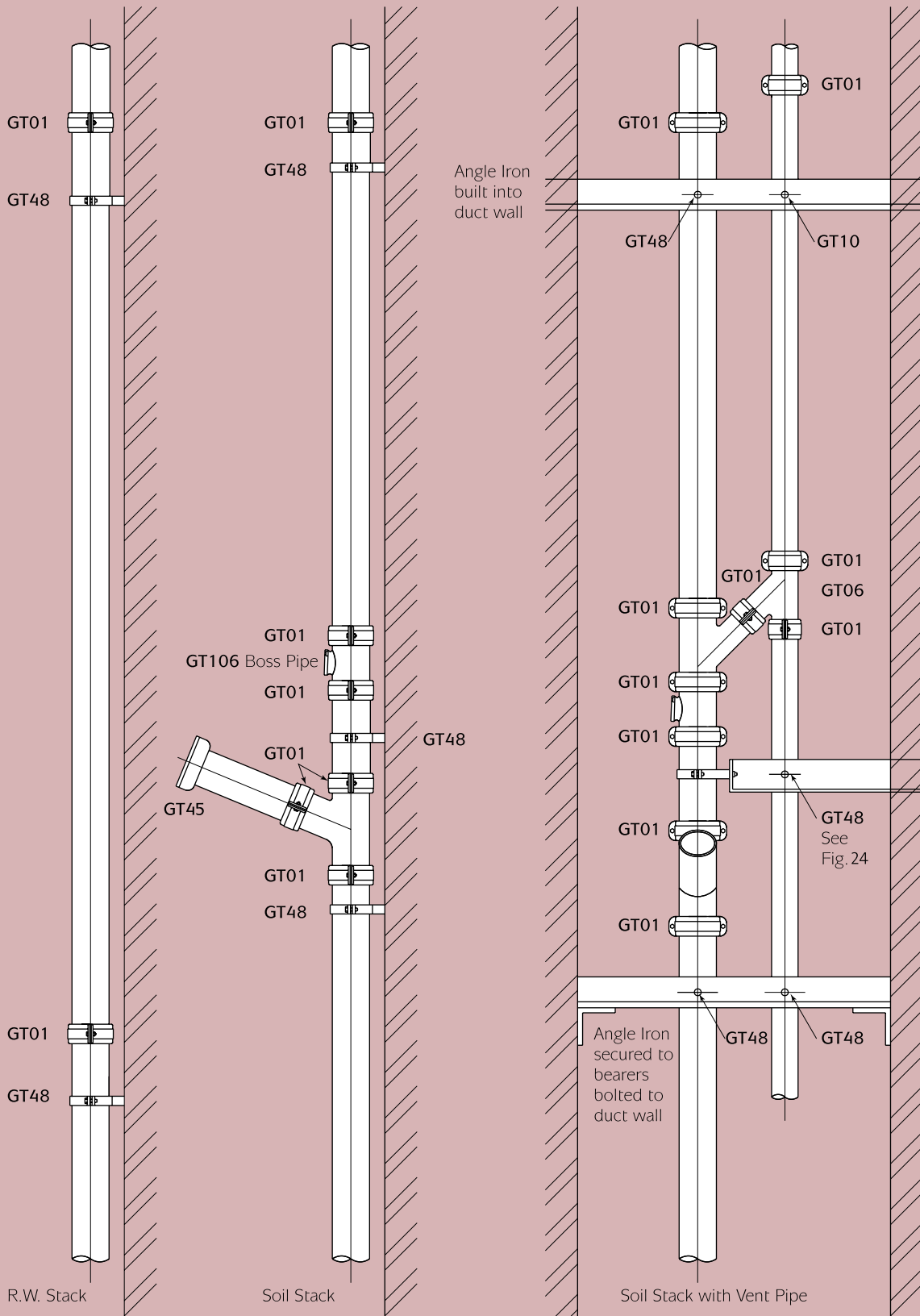

Fig. 22

Fig. 23

Fig. 23a

Support for vertical pipework

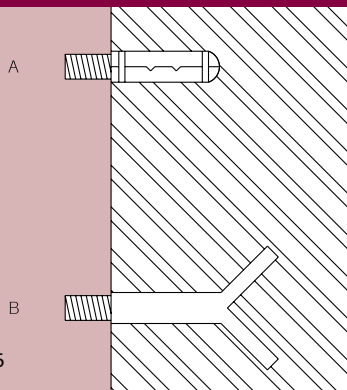

Fig. 26

Suggested fixing methods

- A. Expanding type fixing with stud
- B. Build in or drive in type fixing

Support for vertical pipework

For vertical soil or rainwater stacks, it is recommended that a load bearing bracket be fitted to each floor level to carry the weight of the soil stack. This is of particular importance on multi-storey applications. These brackets should be tightened as the stack is built up so that each floor height is self-supporting and undue pressure is not imposed on the base of the stack.

Where stacks are located at standard distances from wall or column, i.e. 32 from back of pipe to wall face, 50 and 75 diameters and 38 for 100, 150 diameters. RW stacks, (Fig. 22), one bracket GT48 per length will be adequate. Soil stacks, (Fig. 23) may require an extra bracket on or adjacent to the boss pipe in order to ensure correct alignment of stack.

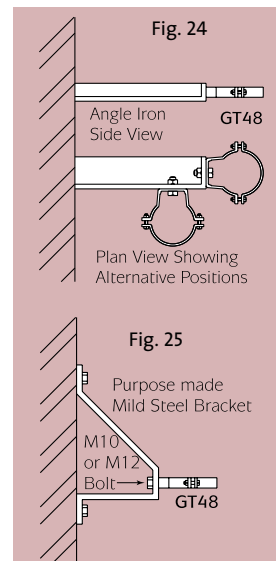

Support for low gradient pipework

The distance between pipe supports should not exceed 3m. Supports should be adjacent to joints and adequate to carry the weight of pipe plus contents. Where the layout requires shorter lengths than the maximum, support distances should be adjusted to suit.

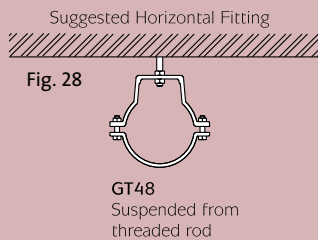

Fig. 28

GT48
Suspended from
threaded rod

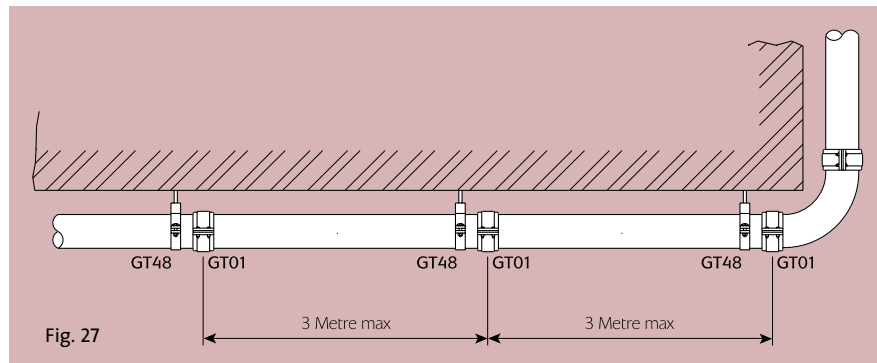

Fig. 27

Acoustic bracket



The GT48 ductile iron bracket fitted with the new acoustic dampener achieves an exceptionally low level of noise transition (see table). The dampener fits all GT48 bracket sizes (50-150mm) and is supplied assembled.

	Airborne sound pressure level dB(A)		Structure borne sound characteristic level dB(A)	
	2.0	4.0	2.0	4.0
Flow rate (l/s)	2.0	4.0	2.0	4.0
Ductile iron bracket fitted with acoustic dampener	45	47	5	11

Vertical pipe stack – one acoustic bracket per 3 metre

Horizontal suspended pipework – two acoustic brackets minimum per 3 metre

Connection to other materials

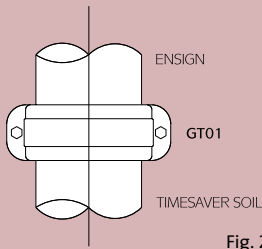

Fig. 29

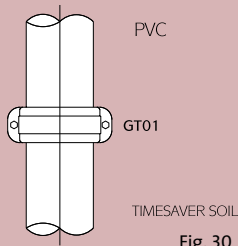

Fig. 30

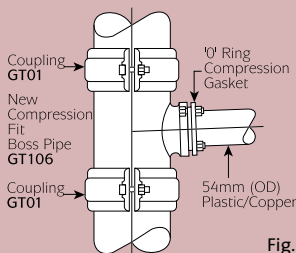

Fig. 31

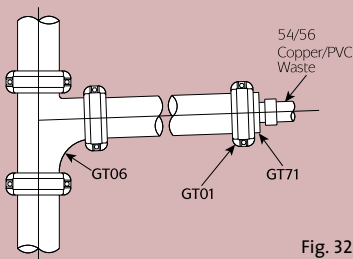

Fig. 32

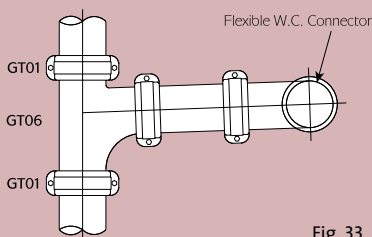

Fig. 33

A. Timesaver soil dimensions

Most materials can be connected to Timesaver soil by using a GT01 coupling if their dimensions conform to the following table:

Timesaver soil nominal dia	Min o/dia	Max o/dia
50	59	63
75	85	89
100	109.5	114
150	160	165

B. Ensign

Couple directly to Ensign using a standard coupling GT01, two piece coupling to BS 6087. (see Fig. 29)

C. PVC pipe

100 and 150 PVC can be connected directly to Timesaver soil using a GT01 coupling. (see Fig. 30)

50 PVC can be connected using either the compression boss pipe GT106 (see Fig. 31), or a GT71 (see Fig. 32), both of which are push-fit connection. Alternatively a traditional drilled and tapped boss pipe with 50mm BSPT is available in 100mm diameter.

D. Waste pipes (copper, plastic etc)

These can be connected via a compression boss pipe (see Fig. 31), or a GT71 (see Fig. 32), both of which are push-fit connection. Traditional drilled tapped 50 BSPT options also available.

E. WC connections

Can be achieved directly by using a flexible WC connector (see Fig. 33), or Transitional Connector EF059 (see page 43).

The WC connector requires a caulked joint.

F. Aluminium and stainless steel

If the outside diameter of these fittings conform to Timesaver dimensions a GT01 coupling can be used (see above for dimensions).



Connection to other materials

Fig. 34

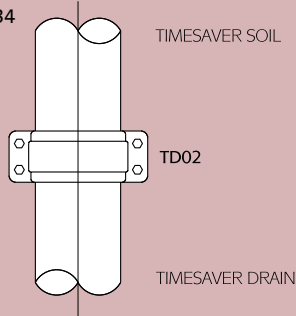

G. Timesaver drain

Couple directly to Timesaver soil using a TD02 coupling (see Fig. 34).

Fig. 35

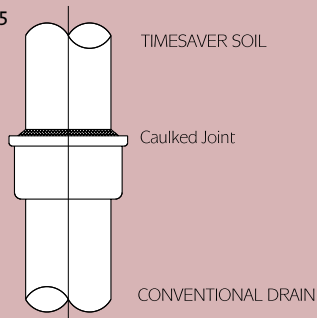

H. Conventional drain

To connect into a conventional drain socket use a caulked joint (see Fig. 35).

Fig. 36

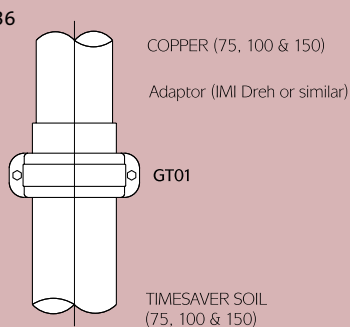

I. Copper

75, 100 and 150 copper can be connected directly to Timesaver soil by using an adaptor available From IMI Dreh or similar and a GT01 coupling (see Fig. 36).

54/56 copper may be connected by a boss pipe (see Fig. 31), or a GT71 (see Fig. 32), both of which are push-fit connection.

Fig. 37

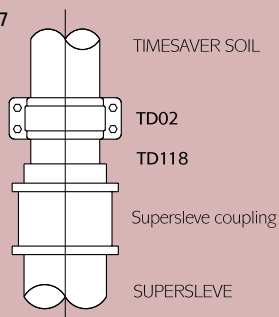

J. Hepworth clayware

100 and 150 Superslave can be connected to Timesaver soil by using a TD118 adaptor and a TD02 coupling (see Fig. 37).

100 and 150 hepslave can be connected to Timesaver soil by using a TD118 adaptor and a TD02 coupling in conjunction with a superslave to hepslave transitional coupling manufactured by Hepworth (see Fig. 38).

Fig. 38

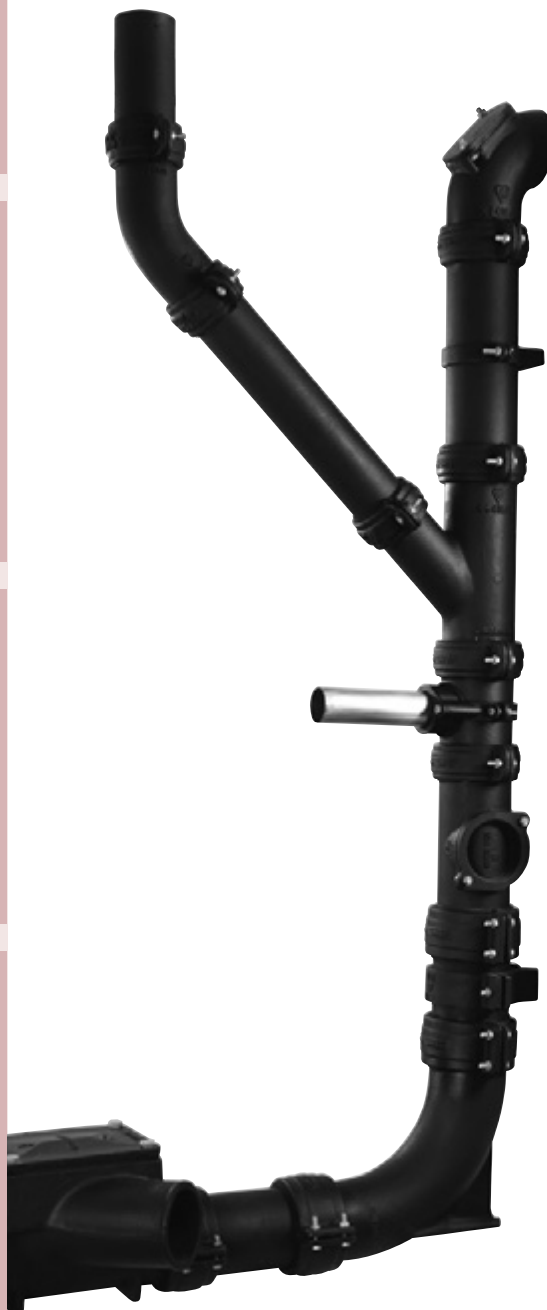
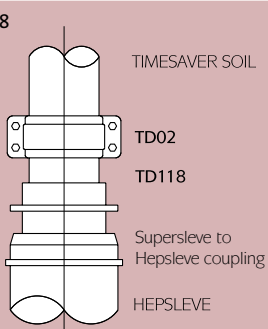

Heritage jointing method



1. Apply a small amount of lubricant (i.e. silicone grease) on the lip of the rubber gaskets, both ends, to ease insertion of pipe/fittings.



2. Push coupling over the end of pipe/ fitting, ensuring the central register is abutted against the spigot edge evenly. If the coupling is eared, fix to wall using anti-corrosion coach screws or similar.



3. Push the second pipe or fitting into the gasket again ensuring that the spigot is abutted against the central register. Timesaver Heritage couplings eared/ plain can be fitted to most fittings within the 50, 75 and 100 diameter ranges (see table page 60).



Three joints used on branches can be very close fitting, in some cases they virtually touch. To accommodate this, the plain joint is designed with a flat area which should be lined up with the adjoining socket, to give maximum clearance (see Fig. 39).

Generally when plain sockets are used, ensure flat area is positioned at the rear of the pipe (nearest the wall) away from view.

Existing systems

If breaking into an existing Timesaver system, a slip joint should be ordered which is designed with a reduced central register. The joint is made by slipping the whole socket onto the pipe, positioning the new fitting then sliding the socket into the desired position.

Connection to conventional soil

Timesaver can connect directly to 90mm (3½") conventional soil by inserting a traditional gasket into the Timesaver Heritage coupling, product code 156132, replacing one of the standard gaskets.

Lubricate the spigot of the 90mm pipe, and push coupling over the pipe inserting 35mm only. Ensure the 90mm pipe is securely fixed to prevent slipping into new pipework.

Fig. 39

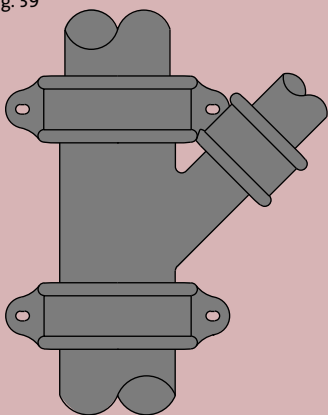

Heritage design recommendations

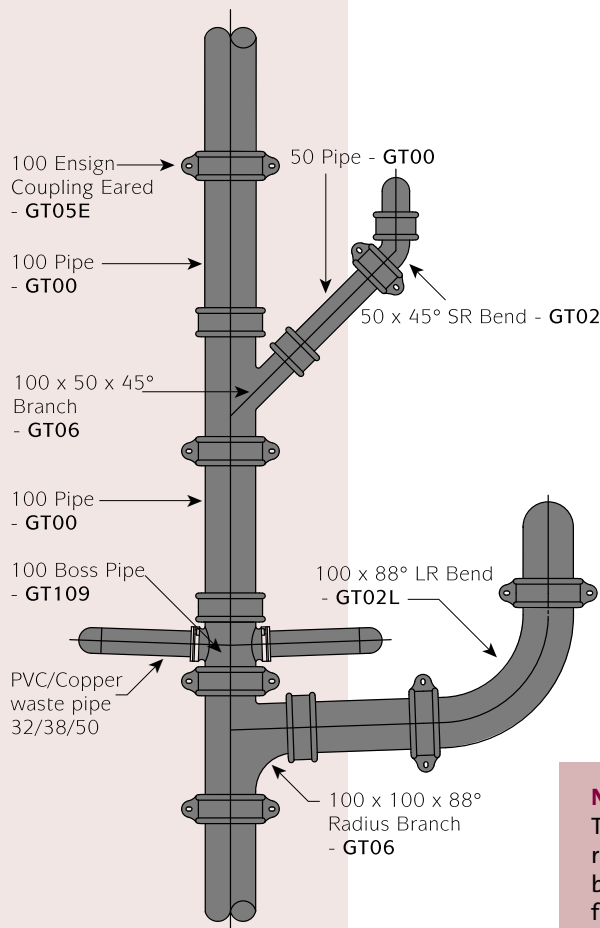
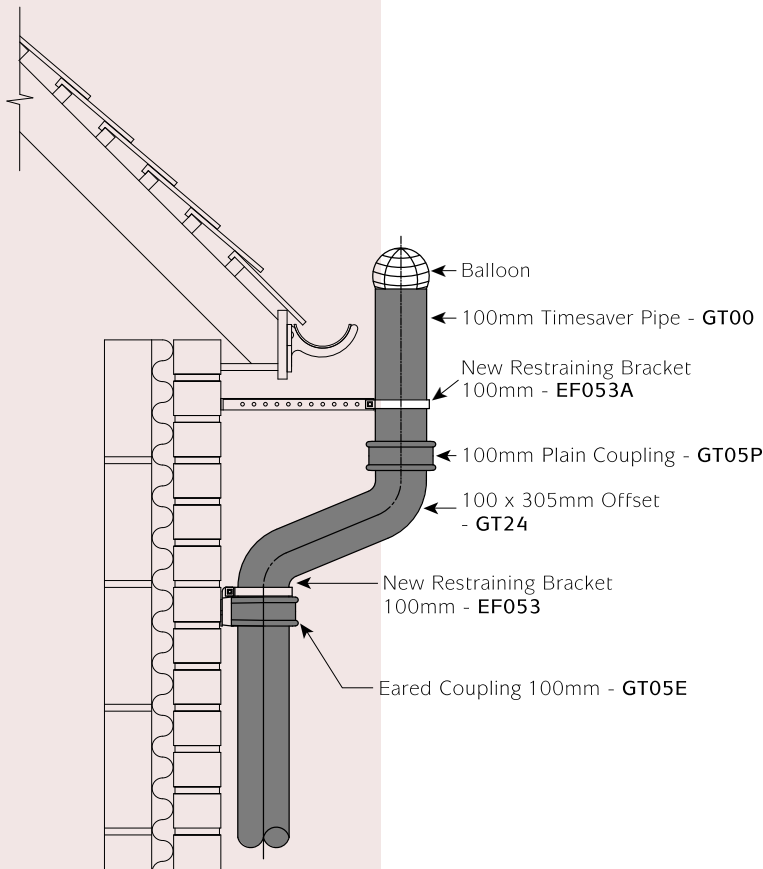

When designing a stack using the new push-fit joint, all fittings require at least one eared socket, to anchor the system to the building. Taking branches as an example, eared joints could be used at the top and bottom of the vertical section to anchor the system, with a plain joint used on the branch arm.

The rubber seals are factory fitted to the socket, and a suitable lubricant (silicone grease) is recommended to ease assembly.

On-site protection

The coating for the Timesaver system is regarded as a primer protection. Therefore when specified for external soil stacks, must be overpainted in accordance with manufacturers recommendations (see page 61).

New restraining brackets EF053 and EF053A. These brackets are designed to give support to the system when in an offset situation. See typical installation opposite.

New restraining bracket EF053 code 192333

To suit 100mm eared coupling GT05E



New restraining bracket EF053A code 192363

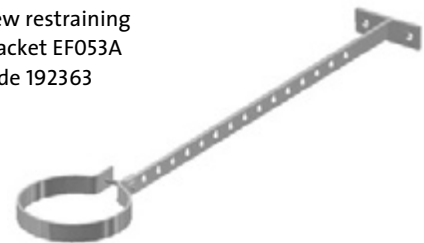

Note:

Timesaver soil fittings were traditionally supplied with a raised bead on the spigot ends, which over the years have been removed. The Heritage couplings can only be used on fittings without the bead.

Heritage Product range compatibility

Timesaver Heritage – product range

List of products within the Timesaver soil range, which can be used with the Timesaver Heritage couplings

Pipe products		Code	50mm Dia.	75mm Dia.	100mm Dia.
Pipe double spigot		GT00			
3m long			●	●	●
1.8m long				●	●
Bends – Short radius plain	67½°	GT02			●
	87½°, 45°		●	●	●
Bends – Short radius door back	87½°	GT03	●	●	●
	45°			●	●
Bends – Short radius door side	87½°	GT04			●
Bends – Large radius plain	87½°, 45°	GT02L		●	●
	22°				●
Bends – Large radius door back	87½°	GT03L		●	●
Bends – Large radius door side	87½°	GT04L			●
Bends – Long tail	87½°	GT43			●
Branches – Plain single equal	87½°, 45°	GT06	●	●	●
Branches – Plain single reducing	87½°, 45° x 50	GT06		●	●
	x 75				●
Branches – Single door back equal	87½°	GT07	●	●	●
Branches – Single door back reducing	87½° x 50	GT07		●	●
	87½° x 75	GT07			●
Branches – Single door side	87½°	GT08/GT09			●
Branches – Double plain	87½°	GT10		●	●
Branches – Double with door	87½°	GT11			●
Access Pipes – Oval door	87½°	GT14		●	●
Access Pipes – Rectangle door	87½°	GT15			●
Offset projection	75mm	GT24		●	●
	115mm			●	●
	150mm			●	●
	225mm				●
	305mm				●
Taper pipe	x 50	GT28		●	●
	x 75				●
‘P’ Trap – Plain		GT34			●
‘P’ Trap – with door		GT37	●	●	●
Blank end – Plain		GT70	●	●	●
Blank end – 50mm push-fit		GT71		●	●
Blank end – 50mm BSPT		GT71T			●
Boss pipe – 50mm single push-fit		GT106	●		●
Boss pipe – 50mm single BSPT		GT106T		●	●
Boss pipe – 50mm double boss opposed – push-fit		GT109			●
Boss pipe – 50mm double boss @90 – push-fit		GT115			●

New bracket EF053/EF053A to suit 100mm eared coupling GTO5E: product code 192333/192363 (see page 42).

New 100mm reducing gasket to 3½" (90mm) conventional soil pipe now available 156132 (see page 42).

General technical details



Testing

It is recommended that pipework installations are tested in sections rather than waiting to complete this in one operation.

Fire proofing

Cast iron has been traditionally used as a pipework material for passing through fire-break partition walls and floors. The TIMESAVER SYSTEM furthers this traditional use. Unlike plastic materials it does not need special protection.

Stoppages and access

In spite of precautions being taken, stoppages may occur and will then require clearing. Ample provision must therefore be provided for access. It is often advantageous to be able to gain access at or near bends including, if possible, the bends leading from the stack to the drain. It is recommended that with a 100 stack, access should be provided at each floor level above or on the WC connection in addition to that at the foot of the stack. With 150 stacks there is less risk of stoppages so it is recommended that access be provided at say every three floors, in addition to that at the foot of the stack. With vented schemes, access should be provided at or near the foot of the stack and at intervals of not more than five floors in height for the purpose of periodic testing.

Coating

All 3m Timesaver pipes are coated externally in black alkyd paint, and internally coated with a two part epoxy paint (ochre colour).

Fittings are coated internally and externally in a black water based paint.

The Timesaver coating shall accept overcoating with alkyd and water based acrylic paints normally used on metallic structures.

Timesaver roof outlets and floor drains are coated in a black water based paint.

Cutting pipes

Timesaver pipe can be readily cut by the use of a powered disc cutter, and wheel cutters.

A chain cutter/snap cutter is not recommended to adequately serve this purpose.

Technical references

It is recommended that these and other listed technical advice, within this manual, are read in conjunction with the following Codes of Practice:

BS EN 12056 Gravity Drainage Systems Inside Building:
Part 2 – Sanitary Pipework
Part 3 – Roof Drainage

BS EN 752 Drains and Sewers Outside Building.

BS 437 and BS 416 Part 2.

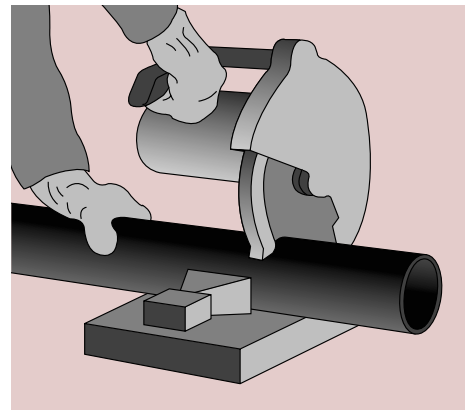

Chemical resistance

Suitability of Timesaver materials – cast iron, EPDM rubber and nitrile rubber

A – RECOMMENDED
X – NOT RECOMMENDED
ND – NO DATA

The information contained in this table has been extracted with permission from Robert Jenkins Systems Ltd. Corrosion Chart.

CHEMICAL	TEMPERATURE °C	COUPLING GASKETS IN EPDM RUBBER			CAST IRON			COUPLING GASKETS IN NITRILE RUBBER		
		20°	60°	100°	20°	60°	100°	20°	60°	100°
ACETALDEHYDE		A	A	ND	A	ND	ND	X	X	X
ACETIC ACID (10%)		A	X	X	X	X	X	X	X	X
ACETIC ACID (GLAC. & ANH.)		X	X	X	X	X	X	X	X	X
ACETIC ANHYDRIDE		ND	ND	ND	A	A	A	X	X	X
ACETO-ACETIC ESTER		A	A	X	X	X	X	ND	ND	ND
ACETONE		X	X	X	A	A	A	X	X	X
ACETONITRILE		ND	ND	ND	X	X	X	ND	ND	ND
ACETYLENE		ND	ND	ND	A	A	A	A	ND	ND
ACETYL SALICYLIC ACID		A	A	ND	X	X	X	A	ND	ND
ALCOHOLS (MOST FATTY)		X	X	X	A	A	A	A	A	A
ALIPHATIC ESTERS		X	X	X	A	A	A	X	X	X
ALUM		A	A	A	X	X	X	A	A	A
ALUMINIUM CHLORIDE		A	A	A	X	X	X	A	A	A
ALUMINIUM SULPHATE		A	A	A	A	A	A	A	A	A
AMMONIA AQUEOUS		A	A	A	A	A	X	A	A	X
AMMONIUM CHLORIDES		A	A	A	A	X	X	A	A	A
ANILINE		X	X	X	A	A	A	X	X	X
AQUA REGIA		X	X	X	X	X	X	X	X	X
ASCORBIC ACID		ND	ND	ND	X	X	X	ND	ND	ND
BEER		A	A	A	A	A	ND	A	A	A
BENZALEHYDE		A	ND	ND	X	X	X	X	X	X
BENZENE PURE		X	X	X	A	A	A	X	X	X
BENZOIC ACID		A	A	A	X	X	X	A	A	A
BENZOYL PEROXIDE		ND	ND	ND	X	X	X	ND	ND	ND
BORIC ACID		A	A	A	X	X	X	A	A	A
BRINES (SATURATED)		A	A	A	A	A	A	A	A	A
BROMIDE (SOLUTION)		A	A	A	X	X	X	A	X	X
BROMINE		ND	ND	ND	X	X	X	X	X	X
BUTYL ACETATE		X	X	X	X	X	X	X	X	X
CALCIUM CHLORIDE		A	A	A	A	A	X	A	A	A
CARBON DISULPHIDE		X	X	X	A	A	A	A	ND	ND
CARBONIC ACID		A	A	A	X	X	X	A	A	A
CAUSTIC SODA & POTASH		A	A	A	A	A	X	A	A	A
CELLULOSE PAINT ND		ND	ND	A	A	ND	X	X	X	
CHLORATES OF Na, K & Ba		A	A	A	X	X	X	ND	ND	ND
CHLORINE		X	X	X	X	X	X	X	X	X
CHLORIDES OF Na, K & Mg		A	A	A	X	X	X	A	A	A
CHLOROACETIC ACIDS		X	X	X	X	X	X	X	X	X
CHLOROBENZENEX		X	X	A	A	A	X	X	X	
CHLOROFORM		X	X	X	A	A	X	X	X	X
CHROMIC ACID		X	X	X	X	X	X	X	X	X
CITRIC ACID		A	A	A	X	X	X	A	A	A
CRESYLIC ACID		ND	ND	ND	X	X	X	X	X	X
CYCLOHEXANE		X	X	X	A	A	A	A	A	A
DETERGENTS		A	A	A	ND	ND	ND	A	A	A
EMULSIFIERS		ND	ND	ND	ND	ND	ND	A	A	A
ETHER		X	X	X	A	A	A	A	X	X
FATTY ACIDS (>C6)		X	X	X	X	X	X	A	X	X
FERRIC CHLORIDE		A	A	A	X	X	X	A	A	A
FERROUS SULPHATE		A	A	A	X	X	X	A	A	A
FLUOSILIC ACID		A	A	A	X	X	X	ND	ND	ND
FORMALDEHYDE		X	X	X	A	X	X	A	X	X
FORMIC ACID		X	X	X	X	X	X	A	X	X
FRUIT JUICES		X	X	X	X	X	X	A	A	A
GELANTINE		A	A	X	A	A	A	A	A	A
GLYCERINE		A	A	A	A	A	A	A	A	A
GLYCOL ETHYLENE		A	A	A	A	A	A	A	A	A
GLYCOLLIC ACID		A	A	A	X	X	X	ND	ND	ND
HEXAMINE		ND	ND	ND	X	X	X	ND	ND	ND
HYDRAZINE		A	ND	ND	ND	ND	ND	A	X	X
HYDROBROMIC ACID (50%)		A	A	ND	X	ND	ND	A	X	X

Chemical resistance

Suitability of Timesaver materials – cast iron, EPDM rubber and nitrile rubber

A – RECOMMENDED

X – NOT RECOMMENDED

ND – NO DATA

The information contained in this table has been extracted with permission from Robert Jenkins Systems Ltd. Corrosion Chart.

CHEMICAL	TEMPERATURE°C	COUPLING GASKETS IN EPDM RUBBER			CAST IRON			COUPLING GASKETS IN NITRILE RUBBER		
		20°	60°	100°	20°	60°	100°	20°	60°	100°
HYDROCHLORIC ACID (10%)		A	A	A	X	X	X	A	A	X
HYDROCHLORIC ACID (CONC)		A	X	X	X	X	X	X	X	X
HYDROCYANIC ACID		A	A	A	X	X	X	A	X	X
HYDROFLUORIC ACID (75%)		X	X	X	X	X	X	X	X	X
HYDROGEN PEROXIDE (30%)		X	X	X	X	X	X	A	X	X
HYDROGEN SULPHIDE		A	A	A	A	X	X	X	X	X
HYPOCHLORITES		A	A	ND	X	X	X	X	X	X
LACTIC ACID		A	A	ND	X	X	X	A	A	X
LIME (CaO)		A	A	A	A	A	A	A	A	A
MEAT JUICES		A	A	A	ND	ND	ND	A	A	A
MERCURIC CHLORIDE		A	A	A	X	X	X	A	A	A
MERCURY		A	A	A	A	A	A	A	A	A
METHANOL		X	X	X	A	A	A	A	A	A
MILK AND ITS PRODUCTS		X	X	X	ND	ND	ND	A	A	A
MOLASSES		ND	ND	ND	A	A	A	A	ND	ND
NITRIC ACID (>25%)		X	X	X	X	X	X	A	X	X
NITROBENZENE		A	A	ND	A	A	A	X	X	X
OILS, DIESEL		X	X	X	A	A	A	A	A	A
OILS, LUBRICATING		X	X	X	A	A	A	A	A	A
OIL, MINERAL		X	X	X	A	A	A	A	A	A
OILS, VEGETABLE & ANIMAL		X	X	X	A	A	A	A	A	A
OXALIC ACID		ND	ND	ND	X	X	X	A	A	X
PARAFFIN		A	A	ND	A	A	A	A	A	A
PETROLEUM SPIRIT		X	X	X	A	A	A	A	A	A
PHOSPHORIC ACID (20%)		A	A	A	X	X	X	A	A	ND
SEA WATER		A	A	A	A	X	X	A	A	A
SILICONE FLUIDS		ND	ND	ND	A	A	A	A	A	A
SODIUM PEROXIDE (10%)		A	A	ND	A	A	A	A	X	X
STARCH		A	A	A	A	A	A	A	A	A
SUGAR, SYRUP, JAMS		X	X	X	A	A	ND	A	A	A
SULPHATES (Na, K Mg, Ca)		A	A	A	A	A	A	A	A	A
SULPHURIC ACID (>50%)		A	A	A	X	X	X	A	X	X
SULPHURIC ACID (70%)		X	X	X	A	X	X	X	X	X
SULPHURIC ACID (90%)		X	X	X	A	A	X	X	X	X
TANNIC ACID (10%)		A	A	A	X	X	X	A	A	X
TARTARIC ACID		A	A	A	X	X	X	A	A	X
TRICHLOROETHYLENE		X	X	X	A	A	X	X	X	X
VINEGAR		X	X	X	X	X	X	A	A	A
WATER		A	A	A	A	A	A	A	A	A
WETTING AGENTS (UP TO 5%)		X	X	X	X	X	X	A	A	A
YEAST		ND	ND	ND	A	A	X	A	ND	ND
ZINC CHLORIDE		A	A	A	X	X	X	A	A	ND

The information given is intended as a guide only and in every case we would wish to know detailed working conditions before advising the suitability of cast iron or our Timesaver coupling gasket.

Care must be taken when more than one of these chemicals is being discharged as interreaction may occur and it is the customer's own responsibility to ensure that the application is suitable. Most of the above should be treated as dangerous wastes and should either be treated before discharging into a sewer or disposed of by other means.

Please note: nitrile gaskets are available to order.

It is recommended that nitrile rubber gaskets be used when the installation is in contact with petrol and oil-based waste substances e.g. garages, petrol stations etc.

Standard specification

Timesaver standard specification and clauses

1.1 Above ground soil, waste, vent and rainwater pipework.

1.2 Cast iron pipes and fittings

- a) The systems shall be designed and installed in accordance with BS EN 12056 code of practice for gravity drainage systems inside buildings and the relevant sections of the Building Regulations.
- b) Soil, waste, vent and rainwater pipework of nominal diameters, 50mm to 150mm shall be installed using cast iron socketless pipe and fittings which fully comply with requirements of product standard BS 416 part 2 with Kitemark third party approval.

Brackets

- c) Pipework shall be supported true to line by methods strictly in accordance with the manufacturer's recommendations. Proprietary adjustable ductile iron hanging brackets such as GT48 shall be used or brackets as recommended by the manufacturer's standard guidelines.
- d) If required, soil, waste, vent and rainwater pipework shall be supported by acoustic brackets that ensure the pipework will not exceed 47dB (A) airborne noise and 11dB (A) structure-borne noise at 4 L/s (litres per second), without insulation as recommended by the manufacturer's standard guidelines.

Jointing

Standard couplings

- e) Pipes and fittings shall be jointed by two part ductile iron couplings capable of withstanding up to 5bar (accidental static water pressure) when suitably restrained with support brackets. Couplings to be fitted with EPDM rubber gasket as supplied.
- f) Couplings shall be fitted with steel continuity clips (supplied separately) if equipotential bonding (earthing) has been specified. Coupling colour shall match the pipes and fittings.

Push-fit Heritage couplings

- g) Pipes and fittings shall be jointed by Timesaver Heritage push-fit couplings incorporating 2 EPDM gaskets that give the appearance of a traditional socket as depicted in BS 416 part 1.

Fittings

- h) Where possible all 88 degree branches shall be radius curve entry (conforming to BS EN 12056-2:2000).
- i) Small diameter waste pipes in plastic or copper to be connected to the main soil pipework using either mechanical compression-fit or BSP threaded boss pipes or blank ends.

Cutting pipes

- j) Where pipes are cut on site, ends shall be cut clean and square with all burrs removed. In most cases it is not necessary to re-coat the pipe ends with 'touch up paint'. However, where there may be aggressive materials passing through the drainage system (i.e. Coca-Cola; acid rain; acids or strong alkaline or similar substances), it is necessary to protect the cut ends of the pipework to the same standard as the internal coating of the pipe (as recommended by the manufacturer).

Coating

- k) 3 metre pipes shall be externally coated with a black alkyd primer paint. Internally coated with a two-part epoxy coating, ochre in colour, with an average thickness of 130 microns.
- l) 1.8 metre (6ft) Heritage pipes shall be coated internally and externally with a black water based paint.
- m) Fittings/couplings/brackets shall be protected internally and externally with a black water based paint.

Timesaver standard specification

1.1 Below ground buried foul and stormwater pipework.

1.2 Cast iron pipes and fittings

- a) The systems shall be designed and installed in accordance with BS EN 12056 code of practice for gravity drainage systems inside buildings, BS EN 752-1 for drain and sewer systems outside buildings and the relevant sections of the Building Regulations.
- b) Foul and stormwater pipework of nominal diameters, 100, 150 and 225mm shall be installed using cast iron socketless pipe and fittings which fully comply with all requirements of product standard BS 437 with kitemark third party approval.

Brackets

- c) Pipework shall be supported true to line by methods strictly in accordance with the manufacturer's recommendations. Proprietary adjustable ductile iron hanging brackets as TD 640 shall be used or brackets as recommended by the manufacturer's standard guidelines.

Jointing

Standard couplings

- d) Pipes and fittings shall be jointed by ductile iron couplings capable of withstanding up to 5bar (accidental static water pressure) when suitably restrained with support brackets. Coupling colour shall match the pipes and fittings, and incorporate stainless steel socket cap screws and nuts wax coated.

Fittings

- e) Junctions between pipes should use the proprietary cast iron chamber, or standard branch type fittings as recommended by the manufacturer.

Cutting pipes

- f) Where pipes are cut on site, ends shall be cut clean and square with all burrs removed. In most cases it is not necessary to re-coat the pipe ends with 'touch up paint'. However, where there may be aggressive materials passing through the drainage system (i.e. Coca-Cola; acid rain; acids or strong alkaline or similar substances), it is necessary to protect the cut ends of the pipework to the same standard as the internal coating of the pipe (as recommended by the manufacturer).

Coating

- g) Pipes shall be externally coated with a black alkyd primer paint. Internally coated with a two-part epoxy coating, ochre in colour, with an average thickness of 250 microns.
- h) Fittings/couplings/brackets shall be protected internally and externally with a black water based paint.

FLOOR DRAINS

Gratings

150mm Circular Grating	66
150 x 150mm Square Grating	66
200 x 200mm Square Grating	66

Rodding Eyes

150mm Circular Rodding Eyes	67
150 x 150mm Square Rodding Eyes	67
200 x 200mm Square Rodding Eyes	67

Gratings for Vinyl Floors

150mm Circular Grating	68
------------------------	----

Rodding Eyes for Vinyl Floors

150mm Rodding Eye	68
Cast Iron Gratings	68

Gully Bodies

Gully Bodies (Non-Trapped)	69
Gully Bodies (Trapped)	70

Accessories

Cast Iron Raising Pieces	71
Spigot Adaptor	71
Reducing Bushes	71
Oval Funnel	72
Circular Funnel	72
Security Screws	72
Airtight Bung	72

SHOWER DRAINS

Shower Drains Bodies

Cast Iron Vertical Shower Drain	73
Cast Iron Horizontal Shower Drain	73
50mm Removable Bottle Trap	73
Filter Basket	73

Shower Drain Gratings

150mm Circular Grating for Vinyl Floor	74
150mm Circular Decorative Grating for Vinyl Floor	74
150 x 150mm Square Grating for Tiled Floor	74
150 x 150mm Square Decorative Grating for Tiled Floor	74
Shower Drain Kits	74

ROOF OUTLETS

Vertical	75
Balcony Spigot – Flat Grating	76
Balcony Spigot – Notched Grating	76
Balcony Threaded – Flat Grating	76
Balcony Threaded – Notched Grating	76
Two-Way Outlets	77

Raising Pieces

Vertical Outlet	77
Balcony Outlet	77

Gravel Guard

77

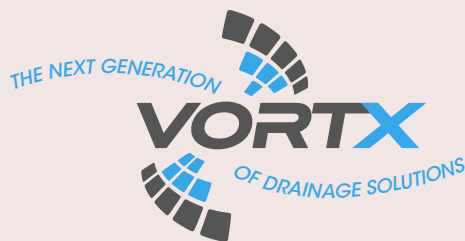

Gratings

Height Adjustable

Grating bodies are threaded NPSM supplied in both nickel bronze and stainless steel for typical use with tiles, marble, terrazzo, vinyl and resin floor finishes. Supplied with standard screw fixings – security screws are available which can be ordered separately.

All gratings and rodding eyes are K3 loading class and may be supplied in a polished finish (to order) and can be installed with a removable bottle trap[®] where required (see page 60).

Direct Fit

All VortX gratings and rodding eyes in both nickel bronze and stainless steel are available for direct fit connection to pipework when a gully body is not required. Ideal for connection to Ensign cast iron pipework to BS EN 877, however, the direct fit VortX gratings will connect to all pipe materials 110 OD. For other OD pipework stepped couplings or adaptors may be required (check with Technical 01952 262529).

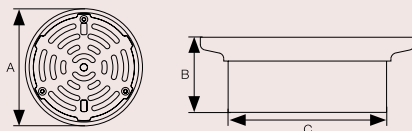

150mm Circular Grating (NPSM threaded or Direct Fit)

GEN code	Material	FIT	Finish		A	B	C	wt/kg	Grating free area (cm ²)	Load class
VX-F010	Nickel Bronze	NPSM	Standard 227049	Polished 234170	150	53	110	1.7	72	K3
VX-F010	Nickel Bronze	Direct Fit	Standard 233415	Polished 234171	150	53	110	1.5	72	K3
VX-F020	Stainless Steel	NPSM	Standard 227050	Polished 234172	150	53	110	1.5	72	K3
VX-F020	Stainless Steel	Direct Fit	Standard 233407	Polished 234173	150	53	110	1.5	72	K3

If bottle trap[®] required, see page 73.

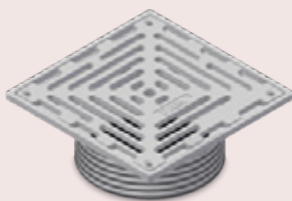
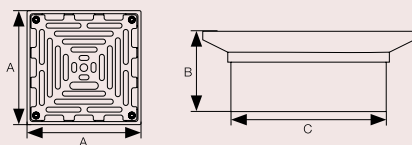
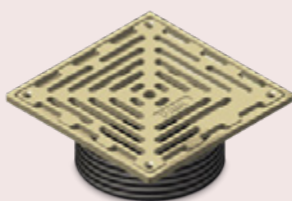

150 x 150mm Square Grating (NPSM threaded or Direct Fit)

GEN code	Material	FIT	Finish		A	B	C	wt/kg	Grating free area (cm ²)	Load class
VX-F030	Nickel Bronze	NPSM	Standard 227101	Polished 234174	150	57	110	1.3	119	K3
VX-F030	Nickel Bronze	Direct Fit	Standard 233408	Polished 234175	150	57	110	1.3	119	K3
VX-F040	Stainless Steel	NPSM	Standard 227102	Polished 234176	150	57	110	1.2	119	K3
VX-F040	Stainless Steel	Direct Fit	Standard 233421	Polished 234177	150	57	110	1.2	119	K3

If bottle trap[®] required, see page 73.

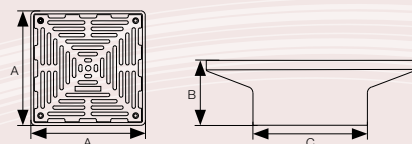
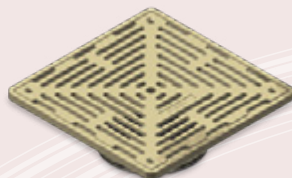

200 x 200mm Square Grating (NPSM threaded or Direct Fit)

GEN code	Material	FIT	Finish		A	B	C	wt/kg	Grating free area (cm ²)	Load class
VX-F050	Nickel Bronze	NPSM	Standard 227103	Polished 234178	200	62	110	3.1	148	K3
VX-F050	Nickel Bronze	Direct Fit	Standard 233423	Polished 234179	200	62	110	3.1	148	K3
VX-F060	Stainless Steel	NPSM	Standard 227104	Polished 234180	200	62	110	2.8	148	K3
VX-F060	Stainless Steel	Direct Fit	Standard 233424	Polished 234181	200	62	110	2.8	148	K3

If bottle trap[®] required, see page 73.

Rodding Eyes

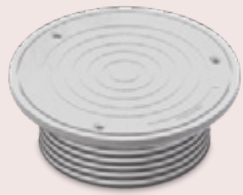
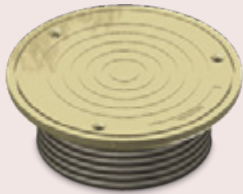
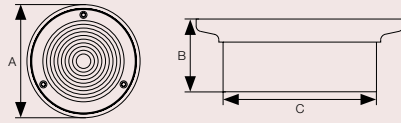

150mm Circular Rodding Eyes (NPSM threaded or Direct Fit)

GEN code	Material	FIT	Finish		A	B	C	wt/kg	Load class
VX-F015	Nickel Bronze	NPSM	Standard 227105	Polished 234182	150	53	110	1.8	K3
VX-F015	Nickel Bronze	Direct Fit	Standard 233426	Polished 234183	150	53	110	1.8	K3
VX-F025	Stainless Steel	NPSM	Standard 227106	Polished 234184	150	53	110	1.6	K3
VX-F025	Stainless Steel	Direct Fit	Standard 233427	Polished 234185	150	53	110	1.6	K3

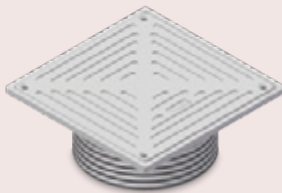
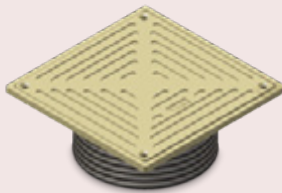
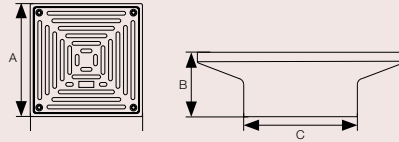

150 x 150mm Square Rodding Eyes (NPSM threaded or Direct Fit)

GEN code	Material	FIT	Finish		A	B	C	wt/kg	Load class
VX-F035	Nickel Bronze	NPSM	Standard 227107	Polished 234187	150	57	110	1.4	K3
VX-F035	Nickel Bronze	Direct Fit	Standard 233428	Polished 234188	150	57	110	1.4	K3
VX-F045	Stainless Steel	NPSM	Standard 227108	Polished 234189	150	57	110	1.3	K3
VX-F045	Stainless Steel	Direct Fit	Standard 233430	Polished 234190	150	57	110	1.3	K3

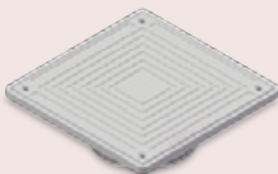
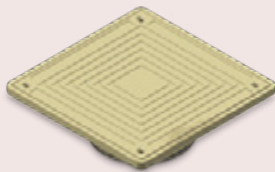
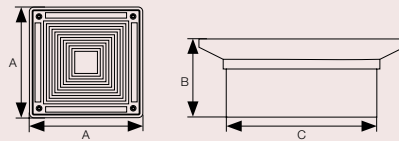

200 x 200mm Square Rodding Eyes (NPSM threaded or Direct Fit)

GEN code	Material	FIT	Finish		A	B	C	wt/kg	Load class
VX-F055	Nickel Bronze	NPSM	Standard 227109	Polished 234191	200	62	110	3.4	K3
VX-F055	Nickel Bronze	Direct Fit	Standard 233431	Polished 234192	200	62	110	3.4	K3
VX-F065	Stainless Steel	NPSM	Standard 227110	Polished 234193	200	62	110	3.1	K3
VX-F065	Stainless Steel	Direct Fit	Standard 233433	Polished 234194	200	62	110	3.1	K3

Gratings for Vinyl Floors

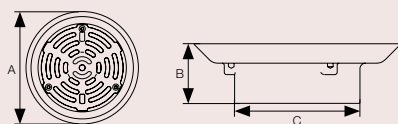

150mm Circular Grating (NPSM threaded or Direct Fit)

GEN code	Material	FIT	Finish		A	B	C	wt/kg	Grating free area (cm ²)	Load class
VX-F070	Nickel Bronze	NPSM	Standard 227111	Polished 234195	170	53	110	2.3	72	K3
VX-F070	Nickel Bronze	Direct Fit	Standard 233434	Polished 234196	170	53	110	2.3	72	K3
VX-F080	Stainless Steel	NPSM	Standard 227112	Polished 234197	170	53	110	2.1	72	K3
VX-F080	Stainless Steel	Direct Fit	Standard 233435	Polished 234198	170	53	110	2.1	72	K3

If bottle trap[®] required, see page 73.

Rodding Eyes for Vinyl Floors

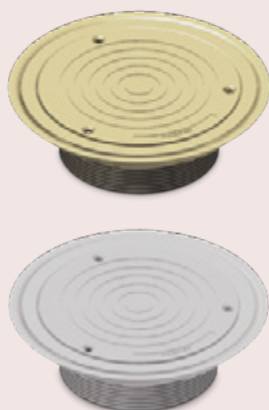
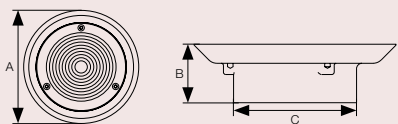

150mm Rodding Eye (NPSM threaded or Direct Fit)

GEN code	Material	FIT	Finish		A	B	C	wt/kg	Grating free area (cm ²)	Load class
VX-F075	Nickel Bronze	NPSM	Standard 227113	Polished 234199	170	53	110	2.4	N/A	K3
VX-F075	Nickel Bronze	Direct Fit	Standard 233438	Polished 234200	170	53	110	2.4	N/A	K3
VX-F085	Stainless Steel	NPSM	Standard 227114	Polished 234201	170	53	110	2.2	N/A	K3
VX-F085	Stainless Steel	Direct Fit	Standard 233439	Polished 234202	170	53	110	2.2	N/A	K3

Cast Iron Gratings

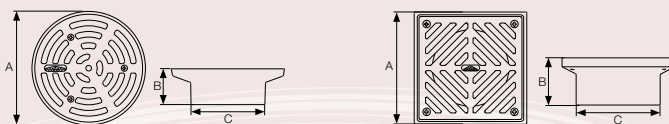

150mm Circular Cast Iron Grating

GEN code	SAP Code	Fit	A	B	C	wt/kg	Grating free area (cm ²)	Load class
VX-F090	247771	NPSM	182	57	119	2.9	72	L15
VX-F090	247773	Direct	182	57	119	3	72	L15

150 x 150mm Square Cast Iron Grating

GEN code	SAP Code	Fit	A	B	C	wt/kg	Grating free area (cm ²)	Load class
VX-F100	247772	NPSM	150	63	119	2.9	119	L15
VX-F100	247774	Direct	150	63	119	3	119	L15

Gully Bodies (Non-Trapped)

Gully Bodies (Non-Trapped)

The VortX gully bodies are manufactured in cast iron, trapped or non-trapped, NPSM threaded to accept raising pieces and gratings.

The VortX bodies have been designed to reduce the chance of build up of debris and provide improved flow. The unique flange design has 4 identification rings that give an excellent key to the waterproofing membrane or final floor finish and has dimples to assist drill location for fixing to the structural floor removing the requirement for a deck clamp.

All gully bodies are supplied in a grey epoxy coating consistent with BS EN 877 fittings.

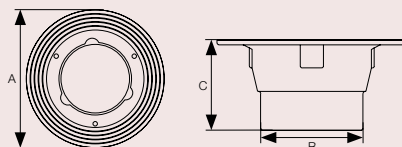

Medium Sump Body (110mm Outlet)

GEN code	SAP code	A	B	C	wt/kg
VX-F200	227119	205	110	100	2.4

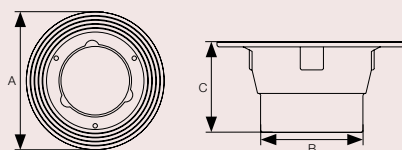

Medium Sump Body (Threaded 4" BSP)

GEN code	SAP code	A	B	C	wt/kg
VX-F200	227118	205	121	100	2.6

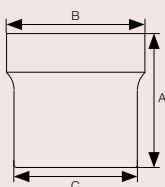
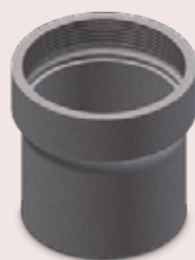

Sumpless Body (110mm outlet)

GEN code	SAP code	Material	A	B	C	wt/kg
VX-F210	227120	Cast Iron	124	120	110	1.6

Gully Bodies (Trapped)

Gully Bodies (Trapped)

New innovative “P” and “S” trap designs are lighter in weight and minimise the space required that is needed by the more traditional products on the market. Supplied with 110mm spigot outlets, three plugged 2” BSP inlets incorporating the same flange design features and can be installed with the standard clamp ring if required.

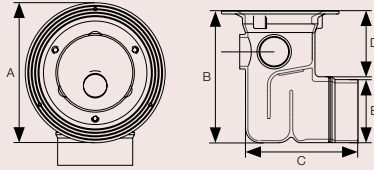

P Trap (110mm outlet)

GEN code	SAP code	A	B	C	D	E	wt/kg
VX-F220	227129	205	230	196	115	110	5.6

Registered Design 1345789-0001

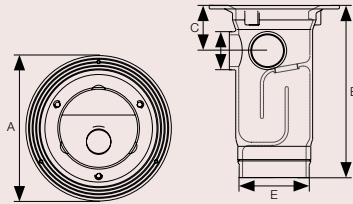

S Trap (110mm outlet)

GEN code	SAP code	A	B	C	D	E	wt/kg
VX-F230	227130	205	295	72	60	110	5.6

Registered Design 1345789-0002

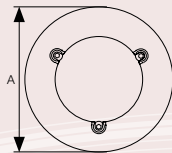

Clamping Ring (to suit all gullies)

GEN code	SAP code	Material	A	B	wt/kg
VX-F205	223440	Cast Iron	205	12	0.9

Accessories

Raising Pieces

Supplied in grey epoxy coated cast iron, NPSM threaded and in three standard height sizes to provide additional adjustment for the gratings and rodding eyes.

Adaptors

Manufactured in cast iron – BSP threaded which are available in a number of diameters to connect to the 4" BSP floor drain body utilising reducing bushes. The adaptors allow connection to cast iron, PVC and other materials.

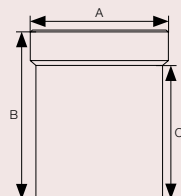
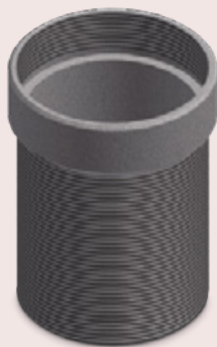

Cast Iron Raising Pieces (NPSM threaded)

GEN code	SAP code	Size	A	B	C	wt/kg
VX-F350	227123	95-140	120	155	120	2.0
VX-F350	227122	40-95	120	117	80	1.5
VX-F350	227121	20-40	120	62	25	0.8

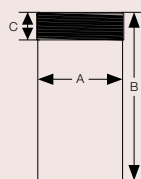

Spigot Adaptor (BSP)

GEN code	SAP code	Size	A	B	C	wt/kg
VX-F500	227131	110 to 4" (BSP)	110	215	35	2.7
VX-F500	234204	80 to 3" (BSP)	80	215	27	2.1
VX-F500	234205	60 to 2" (BSP)	60	215	27	1.3
VX-F500	234206	56 to 2" (BSP)	56	215	27	1.1
VX-F500†	247249	160 to 6" (BSP)	160	300	35	6.2

†Use with 150 Vortx Roof Outlets. See page 75.

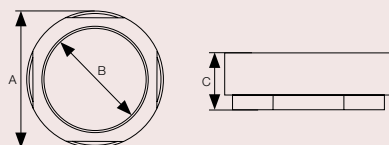
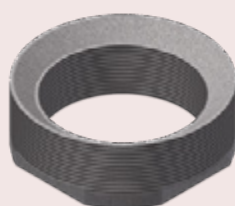

Reducing Bushes (BSP)

GEN code	SAP code	Size	A	B	C	wt/kg
VX-F510	227136	4" x 3" (BSP)	103	75	39	1.1
VX-F510	227137	4" x 2" (BSP)	103	50	40	1.9

Accessories

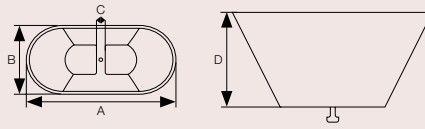

Oval Funnel/VX-F305

SAP code	Material	A	B	C	D	wt/kg
227116	Nickel Bronze	225	100	12	95	0.7

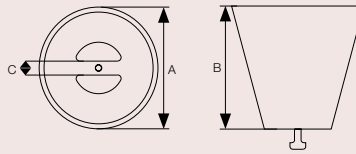

Circular Funnel/VX-F300

SAP code	Material	A	B	C	wt/kg
227117	Nickel Bronze	100	94	12	0.3

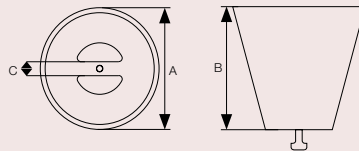

Circular Funnel/VX-F310

SAP code	Material	A	B	C	wt/kg
227115	Stainless Steel	100	94	12	0.2

Security Screws/VX-F420

SAP code	Material	A	B	C	wt/kg
233455	Stainless Steel	-	-	-	0.1

For securing gratings/rodding eyes.



Airtight Bung

GEN code	Material	Code	Size	wt/kg
VX-F420	ABS	241195	105	0.01

To fit all rodding eyes to make double seal.

Shower Drain Bodies

Shower Drain Bodies

Manufactured in cast iron with grey epoxy coating incorporating the VortX styling flange design. The shower gullies are available in 110mm O.D. and 60mm O.D. horizontal spigots and 60mm O.D. vertical spigots. The shower gullies should be fitted with the VortX removable bottle trap[®].

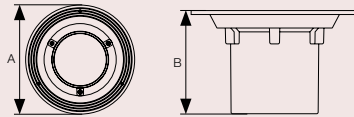

Cast Iron Vertical Shower Drain

GEN code	SAP code	Size	A	B	wt/kg
VX-S260	227125	110mm	210	130	2.4

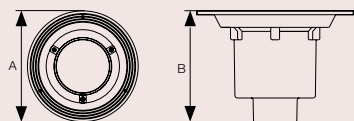

Cast Iron Vertical Shower Drain

GEN code	SAP code	Size	A	B	wt/kg
VX-S260	227126	60mm	210	149	2.4

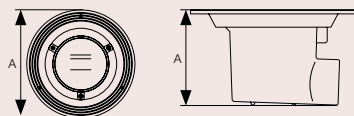

Cast Iron Horizontal Shower Drain

GEN code	SAP code	Size	A	B	wt/kg
VX-S261	227127	60mm	210	121	2.5

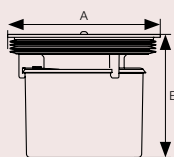

50mm Removable Bottle Trap (Registered design)

GEN code	SAP code	Material	A	B	wt/kg
VX-F400	227128	ABS	111	92	0.1

Registered design number 1285415 – 0001-0005. Can be fitted to gratings nickel bronze/stainless steel.

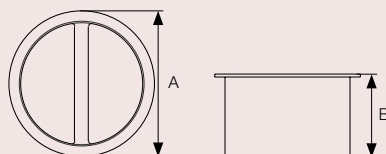
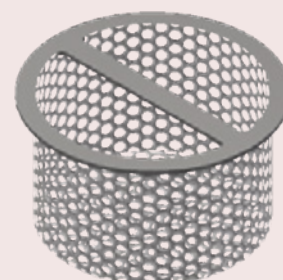

Gravel Guard

GEN code	SAP code	Material	A	B	wt/kg
VX-F410	227138	Stainless Steel	102	60	0.2

Shower Drain Gratings

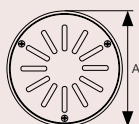

150mm Circular Grating for Vinyl Floor

GEN code	Material	Finish		A	wt/kg	Grating free area (cm ²)	Load class
VX-S270	Stainless Steel	Standard 227132	Polished 234208	150	0.8	21	K3

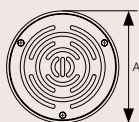

150mm Circular Decorative Grating for Vinyl Floor

GEN code	Material	Finish		A	wt/kg	Grating free area (cm ²)	Load class
VX-S270	Stainless Steel	Standard 227133	Polished 234209	150	0.7	41	K3

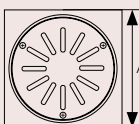

150 x 150mm Square Grating for Tiled Floor

GEN code	Material	Finish		A	wt/kg	Grating free area (cm ²)	Load class
VX-S271	Stainless Steel	Standard 227134	Polished 234210	150	1.0	21	K3

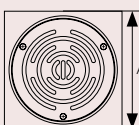

150 x 150mm Square Decorative Grating for Tiled Floor

GEN code	Material	Finish		A	wt/kg	Grating free area (cm ²)	Load class
VX-S271	Stainless Steel	Standard 227135	Polished 234211	150	0.9	41	K3



Example: 50 vertical shower drain with trap and square grating (polished) = 239743

Shower Drain Kits

Kits	Circ Grating VX-S270		Circ Dec Grating VX-S270		Square Grating VX-S271		Square Dec Grating VX-S271	
	Standard 227132	Polished 234208	Standard 227133	Polished 234209	Standard 227134	Polished 234210	Standard 227135	Polished 234211
100 VX-S260/ VX-F400	239376	239733	239736	239737	239734	239735	239738	239739
50 VX-S260/ VX-F400	239740	239741	239744	239745	239742	239743	239746	239747
50 VX-S261/ VX-F400	239748	239749	239752	239753	239750	239751	239754	239755

The VortX shower drain range is available in complete kits:

- Shower body
- Bottle trap®
- Grating of choice (see table)

Supplied boxed, please contact customer service on 0115 930 0681 or visit www.saint-gobain-pam.co.uk for more information.

Roof Outlets

VortX Roof Outlets

A new range of cast iron roof outlets that offer robust long lasting solutions for most construction market applications. Designed in accordance with BS EN 1253 the range consists of cast iron bodies epoxy coated to the high standard of BS EN 877 with the gratings and clamping rings protected by sheradising. All VortX roof outlets have been flowrate tested and comply fully with the standard and will connect to most drainage systems on the market.

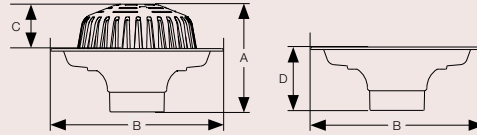

Vertical

GEN code	SAP code	Dia	A	B	C	D	wt/kg	Flow Rate L/S
VX-R105	241181	110	220	350	91	89	8.9	10.7

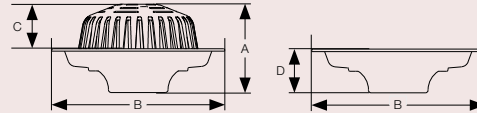

Vertical

GEN code	SAP code	Dia	A	B	C	D	wt/kg	Flow Rate L/S
VX-R155	241183	4" (BSP)	180	350	91	89	8.4	10.7
VX-R155	247413	6" (BSP)	184	386	64	120	12.8	14.5

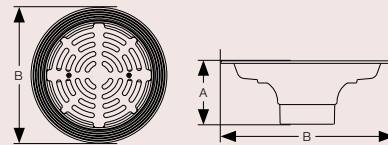

Vertical

GEN code	SAP code	Dia	A	B	wt/kg	Load Class	Flow Rate L/S
VX-R100	241180	110	129	350	10.5	L15	8.1

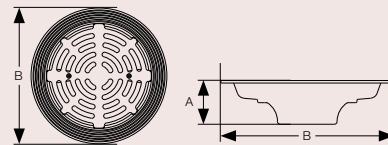

Vertical

GEN code	SAP code	Dia	A	B	wt/kg	Load Class	Flow Rate L/S
VX-R150	241182	4" (BSP)	89	350	10	L15	8.1
VX-R150	247428	6" (BSP)	64	386	14.8	L15	14.2

Roof Outlets

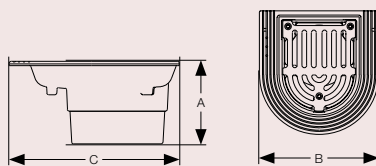
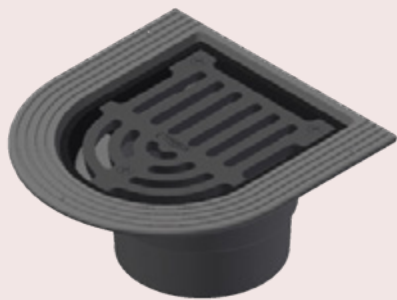

Balcony Spigot – Flat Grating

GEN code	SAP code	Spigot Dia	A	B	C	wt/kg	Flow Rate L/S
VX-R300	241184	110	100	200	210	3.6	4.99

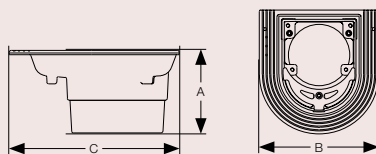
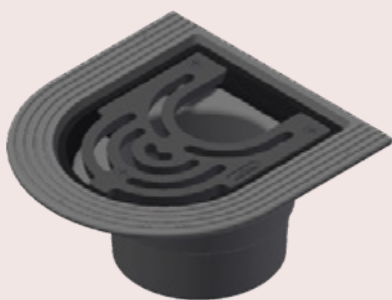

Balcony Spigot – Notched Grating

GEN code	SAP code	Spigot Dia	Pipework Dia	A	B	C	wt/kg	Flow Rate L/S
VX-R305	241187	110	100	100	200	210	3.2	4.99
VX-R305	241186	110	75	100	200	210	3.4	4.15
VX-R305	241185	110	50	100	200	210	3.5	1.41

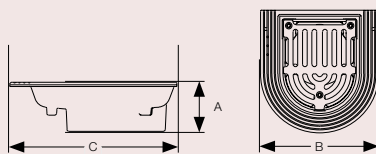
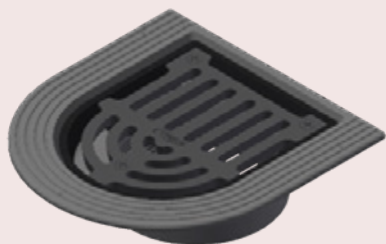

Balcony Threaded – Flat Grating

GEN code	SAP code	Spigot BSP	A	B	C	wt/kg	Flow Rate L/S
VX-R350	241188	4"	60	200	210	3.0	4.99

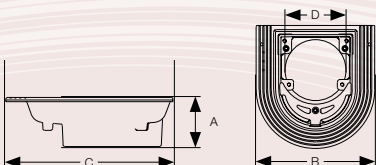
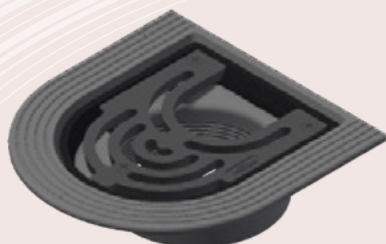

Balcony Threaded – Notched Grating

GEN code	SAP code	Spigot Dia	Pipework Dia	A	B	C	wt/kg	Flow Rate L/S
VX-R355	241191	4"	100	60	200	210	2.3	4.99
VX-R355	241190	4"	75	60	200	210	2.8	4.15
VX-R355	241189	4"	50	60	200	210	2.9	1.41

Roof Outlets

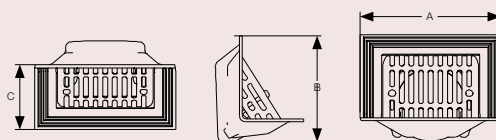
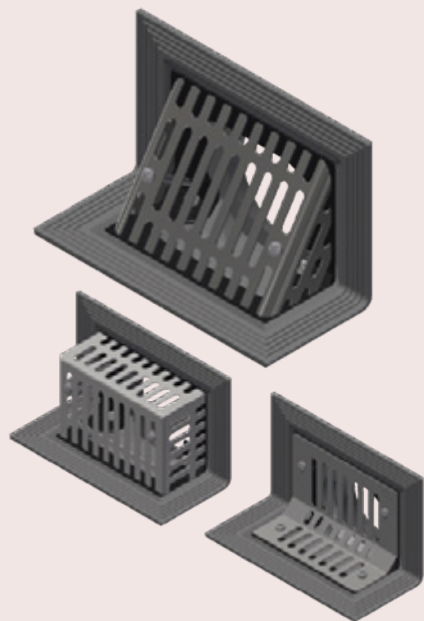

Two-Way Outlet BSP Threaded

GEN code	SAP code	Grating	BSP	A	B	C	wt/kg	Flow Rate L/S
VX-R500	241192	Angled	4"	234	172	111	6.2	1.09
VX-R501	247964	Flat	4"	234	172	111	6.2	1.09
VX-R502	248015	Boxed	4"	234	172	111	6.2	1.09

Stainless steel gratings.

Raising Pieces

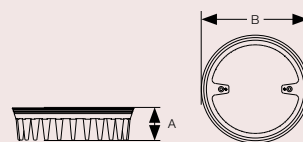

Raising Piece for Vertical Outlet VX-R100/150

GEN code	SAP code	A	B	wt/kg
VX-R710	241193	75	285	2.5

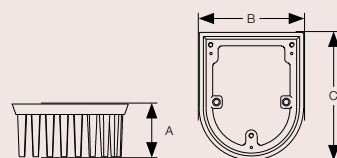

Raising Piece for Balcony Outlet VX-R300/350

GEN code	SAP code	A	B	C	wt/kg
VX-R720	241194	73 (63 effective)	134	165	0.9

Gravel Guard

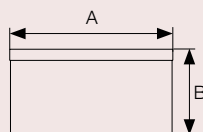
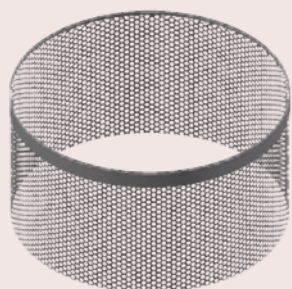

Filter Basket

GEN code	SAP code	Material	A	B	wt/kg
VX-R730	247752	Stainless Steel	291	155	0.2

Please visit our website:

www.saint-gobain-pam.co.uk
to download electronic versions
or to request hard copies of any
of our brochures.

Technical Enquiries

Tel: +44 (0)1952 262529
Fax: +44 (0)1952 262592
Email: technical.soildrain.uk.pam@saint-gobain.com

Sales Enquiries

Tel: +44 (0)115 930 0681
Fax: 0800 019 6523
Email: sales.uk.pam@saint-gobain.com

Head Office

Lows Lane
Stanton-by-Dale
Ilkeston
Derbyshire
DE7 4QU
Tel: +44 (0)115 930 5000



Quality Assurance

Quality Management Systems
BS EN ISO 9001:2008
(Registered firm: 12908)

Environmental Standard

Environmental Management Systems
BS EN ISO 14001:2004

visit: www.saint-gobain-pam.co.uk

The information given in this literature is, to the best of our knowledge, correct at the time of going to print. However, Saint-Gobain PAM UK is constantly looking at ways of improving their products and services and therefore reserve the right to change, without prior notice, any of the data contained in this publication. Any orders placed will be subject to our Standard Conditions of Sale, available on request.

© 2015 Saint-Gobain PAM UK.
Designed by Wyatt International Ltd.

Other products and services available from Saint-Gobain PAM UK:



VortX Floor Drainage

A new generation of floor drainage products designed in accordance with BS EN 1253.



VortX Roof Outlets

A range of cast iron roof outlets designed in accordance with BS EN 1253.



Ensign Cast Iron Drainage

Cast iron above and below ground drainage systems kitemark approved to BS EN 877.

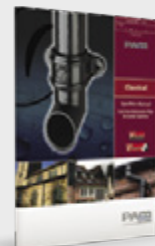

Classical Rainwater

Traditional range of cast iron rainwater and gutter systems to BS 460.



Cyclone Rainwater

Galvanised steel rainwater and gutter systems.



Access Covers and Gratings

UK-manufactured high performing and innovative ductile iron access covers and grating solutions.

Local Distributor

